

MAINE TURNPIKE AUTHORITY

ADDENDUM NO. 3

CONTRACT 2018.20

YORK TOLL PLAZA
MILE 8.8

The bid opening date is October 11, 2018 at 11am.

The following changes are made to the Proposal, Plans and Specifications.

PROPOSAL

Proposal Sheets P-2 through P-27 are deleted and replaced with P-2 through P-27 (Revised 10/4/18). The revisions to these proposal sheets include the following:

Proposal Sheet P-2 added 203.211 Presplitting Rock 400 LF.

Proposal Sheet P-16 deleted the following items:

634.2042	LED Luminaires	Each
634.210	Conventional Light Standard	Each

Proposal Sheet P-16 added the following items:

634.231	Conventional Light Standard with LED Fixture	Each
634.232	Sign Light	Each

PLANS

Plan Sheet 3 of 489, "Estimated Quantities 1" is deleted and replaced in its entirety with attached revised sheet 3 (Revised 10/4/18). The following was deleted:

634.2042	LED Luminaires	Each
634.210	Conventional Light Standard	Each

The following was added:

203.211	Presplitting Rock	LF
634.231	Conventional Light Standard with LED Fixture	Each
634.232	Sign Light	Each

Plan Sheet 152 of 489, "Lighting Plan 1" is deleted and replaced in its entirety with attached revised sheet 152 (Revised 10/4/18). Placement of Light Standard detail was revised.

Plan Sheet 165 of 489, "Lighting Details" is deleted and replaced in its entirety with attached revised sheet 165 (Revised 10/4/18). Placement of Light Standard detail and 24 Inch Foundation detail was revised. Deleted Removal of Concrete Foundation Detail and Placement of Light Standard chart.

Plan Sheet 421 of 489, “Toll General Notes” is deleted and replaced in its entirety with attached revised sheet 421 (Revised 10/4/18). Toll System Integrator notes revised from business days to calendar days.

Plan Sheet 455 of 489, “ITS Plans – CCTV - General Plan at Toll Plaza” is deleted and replaced in its entirety with attached revised sheet 426 (Revised 10/4/18). Notes “2” PVC Conduit – Communications (6 Strand SM Fiber)” revised to “2” PVC Conduit – Communications (6 Strand MM Fiber)”.

Plan Sheet 456 of 489, “CCTV ITS One-Line Diagram” is deleted and replaced in its entirety with attached revised sheet 456 (Revised 10/4/18). Notes with SM Fiber revised to MM Fiber.

Plan Sheet 460 of 489, “Security and Communications - Telecommunications Elevations Details” is deleted and replaced in its entirety with attached revised sheet 460 (Revised 10/4/18). Notes with SM Fiber revised to MM Fiber.

SPECIFICATIONS

Special Provision Section 634 Highway Lighting sheets SP-198 to SP-201 is deleted and replaced with revised sheets SP-198 to SP-201 (Revised 10/4/18).

Special Provision SP-325 to SP-326 is deleted and replaced with revised sheets SP-325 to SP-326 (Revised 10/4/18).

Page SP-325, Special Provision Section 800 New Toll Booth Installation, 800.2 Method of Measurement, second paragraph revised “The Contractor shall transport toll booths from Authority’s Sign Shop Facility Mile 58.3 northbound.” to “The Contractor shall transport toll booths from Authority’s York Maintenance Facility Mile 7.0.”

Page SP-326, Special Provision Section 800 New Toll Booth Installation, 800.2 Method of Measurement, added “The installation toll booths will also include the needed material for securing the toll booth within the booth pit and making it weather tight, which will include but not be limited to (2) 12’ – galvanized steel 3 1/2” X 5” angles and all needed hardware for mounting, installation of aluminum trim angle as detailed on sheet A-05, and installation of sealing material around the HVAC roof penetrations in the toll booth roof.”

Division 800, Specification Section 16800 - Telecommunication Cabling sheets 16800–1 to 16800–13 deleted and replaced with 16800–1 to 16800–13 (Revised 10/4/18). The following was revised:

Division 800, Specification Section 16800 - Telecommunication Cabling sheets 16800–5, deleted and replaced paragraph 2.7:

2.7 MULTIMODE OPTICAL FIBER CABLE

- A. Reference special provisions Section 655 (Communications) for requirements of multimode fiber optic cable.

- B. Manufacturers: Subject to compliance with requirements, available manufacturers offering products that may be incorporated into the Work include, but are not limited to, the following:
 - 1. Corning Cable Systems.
- C. Description: OM1 multimode, 62.5/125-micrometer, nonconductive, indoor/outdoor, tight buffer, optical fiber cable. Provide total number of cables as indicated on plans.
 - 1. Comply with ICEA S-83-596 for mechanical properties.
 - 2. Shall have a minimum of 6 strands.
 - 3. Comply with TIA-568-C.3 for performance specifications.
 - 4. Listed and labeled by an NRTL acceptable to authorities having jurisdiction as complying with UL 444, UL 1651, and NFPA 70 for the following types:
 - a. Plenum Rated, Nonconductive: Type OFNP, dry water blocking, complying with NFPA 262.
 - 5. Maximum Attenuation: 3 dB/km at 850 nm and 1dB/km at 1300 nm.
- D. Jacket:
 - 1. Jacket Color: Orange.
 - 2. Cable cordage jacket, fiber, unit, and group color shall be according to TIA-598-B.
 - 3. Imprinted with fiber count, fiber type, and aggregate length at regular intervals not to exceed 40 inches.

Division 800, Specification Section 16800 - Telecommunication Cabling sheets 16800-5 and 16800-6, deleted and replaced paragraph 2.8:

2.8 OPTICAL FIBER CABLE HARDWARE

- A. Manufacturers: Subject to compliance with requirements, available manufacturers offering products that may be incorporated into the Work include, but are not limited to, the following:
 - 1. Corning Cable Systems.
 - 2. Hubbell Premise Wiring.
 - 3. Molex Premise Networks; a division of Molex, Inc.
 - 4. Ortronics/Legrand
 - 5. Panduit.
- B. Cross-Connects and Patch Panels: Rack mounted modular panels housing multiple-numbered, duplex LC cable connectors. Bi-directions sliding draws for both front and rear access to fibers and fiber optic splice trays.
 - 1. Number of Connectors per Field: One for each fiber of cable or cables assigned to field, plus 25 percent spare and blank positions.
- C. Patch Cords: Factory-made, OM1 multimode single fiber patch cables, with ST connectors at patch panel and LC connectors as required for connection to SFPs, in the following quantities and lengths:
 - 1. Twenty-five (25) – 3-meter lengths - Orange.

D. Pigtails: Factory-made, OM1 multimode single fiber 900micron pigtails.

1. Factory-made.
2. Furnish, and fusion splice, one for each strand of each multimode fiber optic cable for termination onto fiber patch panels.
3. Comply with TIA-568-C.3 performance requirements.
4. ST to pigtail.
5. ST connector housing and boot colors follow TIA-568-C.3 suggested color identification scheme.
6. Insertion loss per connection: 0.1dB typical, 0.25dB maximum.

E. Cable Connecting Hardware:

1. Comply with Optical Fiber Connector Intermateability Standards (FOCIS) specifications of TIA-604-2, TIA-604-3-A, and TIA-604-12. Comply with TIA-568-C.3.
2. Quick-connect, simplex and duplex, Type LC connectors. Insertion loss not more than 0.75 dB.

F. Cable Connecting Hardware:

1. Comply with Optical Fiber Connector Intermateability Standards (FOCIS) specifications of TIA-604-2, TIA-604-3-A, and TIA-604-12. Comply with TIA-568-C.3.
2. Quick-connect, simplex and duplex, Type LC connectors. Insertion loss not more than 0.75 dB.

Division 800, Specification Section 16800 - Telecommunication Cabling sheet 16800–8, 3.3 Installation of Cables, D. Optical Fiber Cable Installation, added:

3. Slack:
 - a. At each manhole a minimum of 50' slack cable coil is required.
 - b. At the communication room terminations, a minimum of 50' slack cable coil is required.

Division 800, Specification Section 16800 - Telecommunication Cabling sheet 16800–11, 3.7 Field Quality Control, part A, section 7. Optical Fiber Cable Tests, added:

- a. All fiber delivered on reel shall be OTDR tested prior to installation, assuring the test match the manufacturer supplied results.

Division 800, Specification Section 16800 - Telecommunication Cabling sheet 16800–12, 3.7 Field Quality Control, part A, section 7. Optical Fiber Cable Tests, sub-section d, deleted and added:

- d. Link End-to-End Attenuation Tests:
 - 1) Multimode measurements: Test at 850nm and 1300nm in both directions (bidirectionally) according to TIA-526-14-A, Method B, One Reference Jumper.
 - 2) Attenuation test results for optical links shall be less than .5dB/km for 1310 and .4dB/km for 1550. Attenuation test results shall be less than that calculated according to equation in TIA-568-C.1.
 - 3) Shall be conducted with an approved OTDR and Power Meter (OLTS).

- a) There shall be no cable end splices between the 2 ends of the cable as shown on the Contract Documents. Splice loss for pigtails shall not exceed .2dB when tested bidirectionally via the OTDR.
- 4) All shall be conducted and analyzed bidirectionally.
- 5) All OTDR and OLTS reports shall be submitted to the Engineer for review and approval before acceptance and use.

Division 800, Specification Section 16825 - Telecommunication Equipment sheets 16825-1 to 16800-11 deleted and replaced with 16825-1 to 16825-11 ((Revised 10/4/18). The following was revised:

Division 800, Specification Section 16825 - Telecommunication Equipment sheets 16825-1, paragraph 1.1 Summary, added:

2. Ethernet Switches and Transceivers.

Division 800, Specification Section 16825 - Telecommunication Equipment sheets 16825-2 and 16825-3, paragraph 2.2 Ethernet Switches, added:

C. ITS Ethernet Switch

1. ITS Ethernet switch shall be a commercial-grade, eight (8) port, 10/100/1000 compliant Ethernet switch with at least four (2) SPF slots supporting industry standard mini-GBIC optical or copper transceivers.
2. Administrative Ethernet switch shall be compatible with EIA 310-D standard, 19-inch (480-mm) panel mounting and be mounted in the Floor-Mounted Equipment Rack in the MTA Communications Room (Room 001A) as indicated on plans.

D. ITS Ethernet to Fiber Transceivers

1. ITS Ethernet to Fiber Transceivers shall be a commercial-grade, 10/100 compliant transceiver (IEEE 802.3 for 10BaseT, IEEE 802.3u for 100BaseT(X) and 100BaseFX, IEEE 802.3x for Flow Control), with one duplex fixed optical ports in SC or ST, and a minimum of one copper ethernet port 10/100BaseT(X) rated for outdoor environments of -40°C to 40°C, DIN Rail mountable, sourced by 120vac power.
2. ITS Ethernet to Fiber Transceivers shall be mounted in ITS Equipment cabinet located at each CCTV, as indicated on plans.

Division 800, Specification Section 16825 - Telecommunication Equipment sheets 16825-4, paragraph 2.7 ITS CCTV Pole, added:

- A. Manufacturers: Subject to compliance with requirements, available manufacturers offering products that may be incorporated into the Work include, but are not limited to, the following:
1. Valmont
 2. Union Metal
 3. Other, as approved by the Engineer

Division 800, Specification Section 16825 - Telecommunication Equipment sheet 16825-5, paragraph 2.8 ITS Equipment Cabinet, added:

- A. Manufacturers: Subject to compliance with requirements, available manufacturers offering products that may be incorporated into the Work include, but are not limited to, the following:
1. Southern Manufacturing
 2. Mass Electrical Apparatuses
 3. Hoffman
 4. Other, as approved by the Engineer

Division 800, Specification Section 16825 - Telecommunication Equipment sheet 16825-6, paragraph 2.9 ITS CCTV Camera, added:

- A. Manufacturers: Subject to compliance with requirements, available manufacturers offering products that may be incorporated into the Work include, but are not limited to, the following:
1. Axis

Division 800, Specification Section 16825 - Telecommunication Equipment sheet 16825-6, paragraph 2.9 ITS CCTV Camera, part B, added: "The Contractor shall furnish and install a Pole Mounted".

Division 800, Specification Section 16825 - Telecommunication Equipment sheets 16825-6 and 16800-8, paragraph 2.9 ITS CCTV Camera, parts H and HH, revised: "DB Entity" to "Contractor"

Division 800, Specification Section 16825 - Telecommunication Equipment sheets 16825-6 and 16825-8, paragraph 2.9 ITS CCTV Camera, parts H, HH and LL, revised: "DB Entity" to "Contractor"

Division 800, Specification Section 16825 - Telecommunications Equipment 16825-1 to 16825-11 deleted and replaced with 16825-1 to 16825-11.

QUESTIONS

The following are questions submitted to the Maine Turnpike Authority in writing. Answers to the questions are noted. Bidders shall utilize this information in preparing their bid.

1. Sheet 422 shows typical loop sensors for all entry lanes for the cash toll booths, with the exterior lane being 19 feet wide will the Gradient Sensor and the Primary Sensor still be placed 1' and 3' respectively from the outside edge of the travel lanes?

Answer: The measurement for loop installation should always be referenced from an island, in all lanes except the wide load lane, the loops are centered, so it doesn't matter which island you are referencing. For the wide load lane, it will be referenced from the island NOT the outside edge.

2. The two work windows for 24 days allowed to complete Phase A and B are provide in the fall of 2019 and the spring of 2020. Would there be a similar window available in the spring of 2019?

Answer: Per addendum 2, Page SP-23, Special Provision 107.4.6 - Prosecution of Work,

Incentive/Disincentive Payments, second paragraph, was updated to include “April 1 to May 3, 2019 or”.

3. Addendum #1 response to Question #14. Is it required that the temporary cover over the stair sections be precast if another option can be demonstrated to not damage the waterstop?
Answer: The temporary covers for the stair sections need not be precast concrete, however, the covers must be designed to carry the same loads to which the covered sections of the precast tunnel are subjected (i.e., traffic load, earth load, etc.).
4. Sheet S-06 The Precast Tunnel cross section provided indicates a clear height of 8’6” and with 12” thick walls/ceiling and ceilings. Past MTA projects have had a 8’0” clear inside height and 10” walls/ceilings. The set-up cost to provide the a taller/thicker walls is a significant. Please confirm the sizes/ wall thickness indicated will be required without exception.
Answer: See Note 1 on Sheet S-06.
5. Sheet S-06 does not dimension the precast corner haunches, however sheet S-07 for the CIP section shows the corner haunches 3” x 3” Due to the physical limitation of precast tunnel connection hardware the 3” x 3” will not be possible. Will there be flexibility based on the manufacturer’s limitations?
Answer: Yes, there is flexibility. Precast designer to propose haunch size for precast tunnel elements for the Engineer’s review. The Engineer will modify the haunch size of the cast-in-place sections to match that of the precast sections (to provide a consistent look throughout the tunnel). However, the Contractor may have to adjust the positioning, and possibly the dimensions, of the diagonal corner bars (TC450s and TS450s), at no additional cost to the Turnpike, such that adequate concrete cover to these bars is provided.
6. In the blasting specifications it calls for no drill holes greater than 3in. in diameter. Will larger drills hole be allowed if it can be shown that all other blasting specifications can be maintained with a larger hole?
Answer: Blast hole diameters shall not exceed 3 inches per the specifications.
7. On General Plan 8 Sheet #101 the Note Reads that “Rock Excavation from STA. 336+00 LT to STA 340+00 LT. Requires Presplitting to Avoid Impacts to Vernal Pool.” There is no pay item for pre splitting. Is this work incidental to rock excavation price?
Answer: The work is not incidental to rock excavation. Item 203.211 Presplitting Rock quantity of 400 LF has been added to P-2 and Sheet 3 of 489.
8. Pay item 203.213 Drilling and Blasting of Solid Rock Subgrade has a pay quantity of 5,700 SY. Where is this work required on the project? Is Drilling and blasting of solid rock subgrade required on the access road?
Answer: The work is estimated at all mainline locations where the bottom of subgrade is in solid rock. This occurs predominantly on Southbound at the widened plaza location.
9. Sheet # SC-7 titled “Security and Communications CCTV pole details” shows pole, camera and security cabinet, but it does not give any reference to a manufacturer or part numbers? Please provide.
Answer: See Specification Section 16825 Telecommunications Equipment for specifics on approved manufacturers of CCTV Poles, CCTV Cabinet, and CCTV Cameras.

10. The above named project has 2ea. 40 foot steel poles with 1 lowering device per pole. I've gone thru the specs and cannot find any SPEC. for the lowering device. Can you possibly point me in the right direction or email the correct spec.
Answer: See Specification Section 16825 Telecommunications Equipment as all requirements for CCTV lowering devices have been removed. MTA does not require the use of lowering devices on their CCTV Poles.
11. Going through the plans and specs they reference the camera lowering devices for the CCTV poles but no where do they give a spec on the lowering devices. If you would please provide a spec on them.
Answer: See Specification Section 16825 Telecommunications Equipment as all requirements for CCTV lowering devices have been removed. MTA does not require the use of Lowering devices on their CCTV Poles.
12. On drawing M-106 detail-A it indicates double wall breeching shall be insulated. Are referring that the breeching requires external insulation as well? If so what type and thickness of insulation will be required?
Answer: As indicated on Drawing M-106, the double-walled breeching in the boiler room shall be insulated. The insulation shall be installed between the inner and outer walls of the breeching. Provide additional insulation on breeching risers to the two (2) boilers/vent outlets for personnel protection.
13. Spec section 15350 page 6 indicates AHU-1 Exhaust with 1" thick duct wrap for sound attenuation, is this insulation to be a sound lagging material or are we just looking to use fiberglass duct wrap with foil facing?
Answer: Specification section 15250, as indicated in section 3.5 Insulation Application Schedule, the exhaust duct shall be insulated with standard fiberglass duct wrap with foil facing.
14. Is it safe to assume that all exposed supply, return and outside air in the mechanical room is to be insulated with rigid board and all concealed supply, return and outside air to be insulated with flexible duct wrap?
Answer: All exposed supply, return, and outside air ductwork in the mechanical rooms and the supply air ducts in the tunnel are to be insulated with rigid board and associated jacket. Exposed supply and return air ductwork in the basement MTA storage are to be insulated with duct wrap. All concealed supply, return, exhaust, and outside air ductwork throughout the Administration Building shall be insulated with flexible duct wrap, as noted in specification section 15250.
15. What type and thickness of insulation will be required for the supply duct in the tunnel?
Answer: Provide 1-1/2 inches thick, rigid board fiberglass insulation for the supply air ductwork with jacket in the tunnel, as noted on the drawing M-111.
16. Water scope for the installation of the water line needs to be complete by 3-21-18? Does the connection across main line (From 16" to Admin Building) fall under this completion date?
Answer: No. The 16" water main shall be installed tested and accepted by March 31, 2018. This includes the installation of the main up to the 16" sleeve connection into existing main at water main station 4015+60 and the installation of the 16"x2" saddle, 2" corporation and 2" tap on the existing main shown on Sheet 463/UT-02.

The water meter, 2” water service line and the service sleeve under the main line to the Administrative Building do not fall under this completion date.

17. Is the installation of the temp widening paid for under the contract items for excavation, gravel, etc. or is it incidental to another item?

Answer: All temporary widening construction is paid for under the appropriate contract items.

18. Is the removal of the temp widening paid for under the contract items for excavation, etc or is it incidental to another item?

Answer: Removal of all temporary widening is paid under contract items.

19. What bid item/items are the USF ponds paid for under?

Answer: The underdrained soil filters are paid for under unit price items as follows:

6” Underdrain Pipe:	Item 605.09 - 6” Underdrain Type B
Type B Underdrain Stone:	Paid as Item 203.35 Crushed Stone fill 3/4 Inch
Geotextile Fabric:	Item 620.56 - Drainage Geotextile
Soil Filter Bed:	Paid as Item 615.07 Loam
Loam and Seed:	Item 615.07 - Loam
Outlet Structure:	Item 604.1542 - 72” Outlet Control Structure
Outfall Pipe:	Applicable pipe pay item
Spillway (Riprap):	Item 610.08 - Plain Riprap
Excavation:	Item 203.20 - Common Excavation
Common Borrow for Berms:	Subsidiary of Item 203.20 - Common Excavation
Clay Borrow:	Item 203.245 - Clay Borrow

Incidental items: Backfill and compaction, spillway crest concrete barrier and footing, any other items shown on the details.

20. Is the temp drainage incidental to MOTCD or is it paid for under a pipe pay item? For example at +/- STA 359+35.63 93.40 RT show 22’ of 12” RCP being installed in a temporary condition. How is this paid?

Answer: Temporary drainage work that is shown on the plans and included the drainage summary table is paid under the applicable pay items. Any additional temporary drainage required for the contractor’s operations is incidental.

21. How is the toll island curb paid for?

Answer: Toll island curbs are paid for under Bid Item Nos. 609.11 and 609.12.

22. For items 625.086, 625.145, and 625.16 is rock excavation incidental or paid for under 206.07?

Answer: Rock excavation for water main and service pipe is paid under item 206.07.

23. Are USF 2-4 in this bid? If so please provide information on them?

Answer: UDSF 2-4 are not included in this bid.

24. Is blasting allowed Friday –Sunday?

Answer: A list of dates and times for allowable blasting times including Friday and Saturday are on SP-226 through SP-228.

25. Is there a pay item for the Pre-split STA 336+00 to 340+00?
Answer: Item 203.211 Presplitting Rock quantity of 400 LF has been added to P-2 and Sheet 3 of 489.
26. Detail # 1 on Sheet 482 of 489 indicates a ¾” drainage mat along the full height of the Cavity Wall. Section 04150, Masonry Accessories in the supplemental specifications does not provide a specification for the ¾” drainage mat. Please provide the specifications for the ¾” drainage mat.
Answer: The full-height masonry drainage mat is specified in Section 04150 – Masonry Accessories; paragraph 2.03.D.
27. Will Zoneguard Steel Barrier be allowed for use as traffic barrier for maintenance of traffic?
Answer: Steel Barrier will be allowed provided all provisions of SP 652 (Temporary Barrier) are met.
28. Specification page SP-21 states: “The system Integrator shall commence ORT lane commissioning testing after both the northbound and southbound ORT facilities are complete and will complete the commissioning no later than 126 calendar days from the Authority’s acceptance that both the northbound and southbound ORT facilities are complete. It is preferred that both northbound and southbound ORT are turned over to the Authority for commissioning testing as the same time, but in no case shall one barrel be turned over to the Authority later than 30 calendar days after the first. The 126 days of commissioning for each bound begins from the Authority’s acceptance of that bound.
Answer: The system integrator requires commissioning both northbound and southbound simultaneously with a maximum of 30 days between Authority’s acceptance of completed northbound and southbound ORT facilities.
29. Specification page SP-22 states: “The system Integrator shall commence cash lane commissioning and testing after both the northbound cash plaza and southbound cash plaza are complete, and will complete the southbound plaza commissioning no later than 70 calendar days, and the northbound plaza commissioning no later than 56 days, from the Authority’s acceptance that both the northbound plaza facility and southbound plaza facility are complete for commissioning.” Drawing Sheet 421 states:

TOLL SYSTEM INTEGRATOR

1. THE CONTRACTOR’S SCHEDULE OF WORK SHALL ACCOUNT FOR THE INSTALLATION OF THE TOLLING EQUIPMENT IN EACH CASH LANE (10 WORKING DAYS PER LANE). ALL CIVIL WORK IN A CASH LANE SHALL BE COMPLETED BY THE CONTRACTOR PRIOR TO THE INSTALLATION OF THE TOLLING EQUIPMENT IN THE RESPECTIVE LANE. TOLLING EQUIPMENT IS TO BE INSTALLED, TERMINATED, AND TESTED BY THE TOLL SYSTEM INTEGRATOR.
2. THE CONTRACTOR’S SCHEDULE OF WORK SHALL ACCOUNT FOR THE INSTALLATION OF THE TOLLING EQUIPMENT IN EACH ORT ZONE (90 WORKING DAYS FOR BOTH ORT ZONES, IF DONE CONCURRENTLY. 90 WORKING DAYS PER ORT ZONE, IF DONE SEPARATELY). ALL CIVIL WORK IN A ORT ZONES SHALL BE COMPLETED BY THE CONTRACTOR PRIOR TO THE INSTALLATION OF THE TOLLING EQUIPMENT IN THE RESPECTIVE ZONES (NB/SB). TOLLING EQUIPMENT IS TO BE INSTALLED, TERMINATED, AND TESTED BY THE TOLL SYSTEM INTEGRATOR.
3. A CASH/ORT LANE SHALL NOT BE OPENED TO TRAFFIC UNTIL ALL TOLLING EQUIPMENT HAS BEEN INSTALLED IN THE RESPECTIVE LANE, HAS BEEN TESTED, AND COMMISSIONING HAS BEEN ACCEPTED BY THE MTA.
4. THE TOLL SYSTEM INTEGRATOR WILL HAVE 10 BUSINESS DAYS PER CASH LANE AND 120 WORKING DAYS PER ORT ZONE (UNLESS DONE CONCURRENTLY). THE CONTRACTOR WILL NEED TO ACCOUNT FOR THE TOLL SYSTEM INTEGRATOR WITHIN THEIR SCHEDULE OF WORK.

Does the system integrator need the time stated on the plans for equipment installation in addition to the time stated in the specifications for testing? If so it does not appear you have provided enough time for the contractor to complete the other work on the project as this would require 90 working days (note 2 on plans) or 120 working days (note 4 on plans) for installation of equipment plus 126 calendar days (page SP-21 in specs) for testing of equipment to complete the work on the ORT. In addition it would require 50 working day (note 1 on plans) for installation of equipment plus 70 calendar days (page SP-22 in specs) for testing of equipment to complete the work on south bound cash lanes which would be the longer of the two cash lanes to complete. If the plans and specifications are referring to the same time allowance for installation and testing then some of the times are in calendar days and some are in working days and would need to be corrected. Please Clarify.

Answer: The 126 calendar days for ORT is the total time the system integrator requires to install tolling equipment and commission ORT. Each cash lane requires 14 calendar days to install tolling equipment and commission. Sheet 421 converted to calendar days.

30. When ledge prevents burying the Habitat Barrier Fence will the chain link fence fabric need to be cut or can the full height of the fabric be set on top of the ledge?

Answer: Where ledge prevents the 5/8" habitat mesh to be embedded, the mesh is to be installed at the full height. The bottom 6 inches, which would otherwise be embedded, shall be folded, and set on top of the ledge.

31. Can the ORT slabs finish be air screened?

Answer: No. An approved bridge deck finishing machine complying MTA Supplemental Specification requirements shall be used for finishing structural concrete ORT Slabs.

32. Question: Would the MTA be able to provide a description of how the HMA berm is to be construction in the HMA Median Barrier Typical as shown in Detail H? Is this berm intended to have the HMA placed in by a machine at in inverted mat or is it something placed in by hand or by a curb machine? If a separate machine was considered would a new item be added to the schedule of items?

Answer: It is intended for that the HMA Berm shall be machined placed. As indicated in the Notes on Sheet 18 the HMA Berm will be paid for under Item 403.2081.

33. Question: Would the MTA allow the utilization of the Littlefield Road (Route 9B) MTA mainline emergency access ramps as a haul route for the project?

Answer: Maine Turnpike Authority may consider the use of the access ramps provided that the Contractor submits a maintenance of traffic plan for review and approval which shows that that use of ramps will be safe. In addition, the access road may need to be upgraded by the contractor before it could be utilized.

ATTACHMENTS

Proposed Sheets P-2 through P-16	(26 pages)
Plan Sheets	(7 pages)
Special Provisions	(6 pages)
Division 800, Specifications	(22 pages)

**SCHEDULE OF BID PRICES
 CONTRACT 2018.20
 YORK TOLL PLAZA
 MILE 8.8**

Item No.	Item Description	Units	Approx. Quantities	Unit Prices in Numbers		Bid Amount in Numbers	
				Dollars	Cents	Dollars	Cents
201.11	Clearing	AC	17				
202.15	Removing Existing Manhole or Catch Basin	EA	22				
202.151	Abandoning Existing Manhole or Catch Basin	EA	10				
202.16	Removing Existing Pipe	LF	575				
202.161	Abandoning Existing Pipe	LF	680				
202.202	Removing Pavement Surface	SY	88,000				
202.205	Rumble Strips - Shoulder	LF	35,500				
202.206	Removing Rumble Strips	LF	6,100				
202.60	Abandon Monitoring Well	EA	2				
203.20	Common Excavation	CY	128,500				
203.21	Rock Excavation	CY	47,300				
203.211	Presplitting Rock	LF	400				
CARRIED FORWARD:							

Item No.	Item Description	Units	Approx. Quantities	Unit Prices in Numbers		Bid Amount in Numbers	
				Dollars	Cents	Dollars	Cents
BROUGHT FORWARD:							
203.213	Drilling and Blasting of Solid Rock Subgrade	SY	5,700				
203.245	Clay Borrow	CY	55				
203.25	Granular Borrow	CY	7,400				
203.35	Crushed Stone Fill 3/4-Inch	CY	550				
205.51	Widening of Existing Shoulder, Plan Quantity	SY	315				
206.07	Structural Rock Excavation - Drainage & Minor Structures	CY	3,200				
206.082	Structural Earth Excavation - Major Structures, Plan Quantity	CY	2,450				
206.092	Structural Rock Excavation - Major Structures	CY	1,980				
304.10	Aggregate Subbase Course-Gravel	CY	115,500				
304.14	Aggregate Base Course - Type A	CY	26,170				
304.15	Aggregate Base Course - Type B	CY	200				
403.207	Hot Mix Asphalt, 19.0 mm Nominal Maximum Size	T	39,750				
403.208	Hot Mix Asphalt, 12.5 mm Nominal Maximum Size	T	550				
CARRIED FORWARD:							

Item No.	Item Description	Units	Approx. Quantities	Unit Prices in Numbers		Bid Amount in Numbers	
				Dollars	Cents	Dollars	Cents
BROUGHT FORWARD:							
403.2081	Hot Mix Asphalt - 12.5 mm Nominal Maximum Size (Polymer Modified)	T	14,300				
403.209	Hot Mix Asphalt 9.5 mm Nominal Maximum Size (sidewalks, drives, islands & incidentals)	T	50				
403.211	Hot Mix Asphalt (Shim)	T	11,500				
403.213	Hot Mix Asphalt 12.5 mm Nominal Maximum Size (Binder)	T	14,240				
409.15	Bituminous Tack Coat - Applied	G	17,675				
419.30	Saw Cutting Bituminous Pavement	LF	3,600				
502.231	Structural Concrete, Space Frame and Overhead Sign Structure Pedestals	CY	155				
502.233	Structural Concrete, Canopy Column Foundations	CY	55				
502.265	Structural Concrete, ORT Slabs	CY	300				
502.266	Structural Concrete, Plaza Structural Slabs	CY	470				
502.267	Structural Concrete, Toll Islands	CY	290				
502.268	Structural Concrete, Utility Pits	CY	60				
502.269	Structural Concrete, CCTV Pole Foundations	CY	14				
CARRIED FORWARD:							

Item No.	Item Description	Units	Approx. Quantities	Unit Prices in Numbers		Bid Amount in Numbers	
				Dollars	Cents	Dollars	Cents
BROUGHT FORWARD:							
502.28	Structural Concrete, Rigid Frame Structures [Tunnel]	CY	170				
503.14	Epoxy-Coated Reinforcing Steel, Fabricated and Delivered	LB	136,500				
503.15	Epoxy-Coated Reinforcing Steel, Placing	LB	136,500				
503.18	Glass Fiber Reinforced Polymer (GFRP) Reinforcing Bars, Fabricated and Delivered	LB	48,000				
503.19	Glass Fiber Reinforced Polymer (GFRP) Reinforcing Bars, Placing	LB	48,000				
503.90	Synthetic Fiber Reinforcement	LB	2,100				
504.80	Space Frame Canopies, Fabricated and Delivered	LS	1				
504.81	Space Frame Canopies, Erection	LS	1				
504.90	Space Frame Steel Support Posts and Anchorage Assemblies	LS	1				
504.91	Mounting Bracket Assemblies	LS	1				
506.15	Shop Coating of New Steel	LS	1				
506.9103	Galvanizing	LS	1				
508.14	High Performance Waterproofing Membrane	SY	1,670				
CARRIED FORWARD:							

Item No.	Item Description	Units	Approx. Quantities	Unit Prices in Numbers		Bid Amount in Numbers	
				Dollars	Cents	Dollars	Cents
BROUGHT FORWARD:							
508.15	Membrane Waterproofing	LS	1				
511.091	Temporary Earth Support Systems	LS	1				
515.2011	Pigmented Concrete Protective Coating - Tunnel Walls & Ceiling	SY	1,330				
515.2012	Pigmented Concrete Protective Coating - Tunnel Floor	SY	455				
515.202	Clear Protective Coating for Concrete Surfaces	SY	1,400				
515.23	Epoxy Overlay	SY	250				
526.306	Temporary Concrete Barrier Type I - Supplied by the Authority	LS	1				
526.351	Median Barrier Type I -Precast	LF	7,000				
526.3511	Median Barrier Type IA - Precast	LF	1,800				
526.3512	Median Barrier Type IB - Precast	LF	870				
526.352	Median Barrier Type II - Precast	LF	240				
526.3522	Median Barrier Type II - Cast in Place	LF	140				
526.3531	Median Barrier Type IIIA - Precast	LF	180				
CARRIED FORWARD:							

Item No.	Item Description	Units	Approx. Quantities	Unit Prices in Numbers		Bid Amount in Numbers	
				Dollars	Cents	Dollars	Cents
BROUGHT FORWARD:							
526.3532	Median Barrier Type IIIB - Precast	LF	180				
526.361	Median Barrier Transition Type I - Precast	EA	4				
526.3611	Median Barrier Transition Type IA - Precast	EA	2				
526.3612	Median Barrier Transition Type IB - Precast	EA	2				
526.3613	Median Barrier Transition Type LP-A	EA	8				
526.3614	Median Barrier Transition Type LP-B	EA	10				
526.362	Median Barrier Transition Type II - Precast	EA	16				
526.371	Median Barrier With Mounted Light Pole Type LP-A - Cast in Place	EA	4				
526.372	Median Barrier With Mounted Light Pole Type LP-B - Cast in Place	EA	5				
527.306	Center Barrier Crash Attenuator	EA	2				
527.341	Work Zone Crash Cushions - TL-3	UNIT	5				
534.71	Precast Concrete Tunnel and Tunnel Staircase Structures	LS	1				
603.155	12 Inch Reinforced Concrete Pipe - Class III	LF	420				
CARRIED FORWARD:							

Item No.	Item Description	Units	Approx. Quantities	Unit Prices in Numbers		Bid Amount in Numbers	
				Dollars	Cents	Dollars	Cents
BROUGHT FORWARD:							
603.159	12 Inch Culvert Pipe Option III	LF	250				
603.165	15 Inch Reinforced Concrete Pipe - Class III	LF	2,375				
603.169	15 Inch Culvert Pipe Option III	LF	450				
603.175	18 Inch Reinforced Concrete Pipe - Class III	LF	940				
603.179	18 Inch Culvert Pipe Option III	LF	100				
603.199	24 Inch Culvert Pipe Option III	LF	25				
603.205	30 Inch Reinforced Concrete Pipe - Class III	LF	64				
603.215	36 Inch Reinforced Concrete Pipe - Class III	LF	64				
603.2353	48 Inch Reinforced Concrete Pipe - Class V	LF	200				
603.28	Concrete Collar for Reinforced Concrete Pipe	EA	10				
603.90	12 Inch Ductile Iron Storm Drain	LF	90				
604.09	Catch Basin Type B1	EA	24				
604.0901	Catch Basin Type B1 with Flat Top	EA	48				
CARRIED FORWARD:							

Item No.	Item Description	Units	Approx. Quantities	Unit Prices in Numbers		Bid Amount in Numbers	
				Dollars	Cents	Dollars	Cents
BROUGHT FORWARD:							
604.152	48 Inch Manhole	EA	7				
604.1542	72 Inch Outlet Control Structure	EA	5				
604.1561	96 Inch Doghouse Manhole	EA	1				
604.1581	Inlet Control Structure	EA	1				
604.26	Catch Basin Type B5	EA	13				
605.09	6 Inch Underdrain Type B	LF	1,450				
605.105	8 Inch Underdrain Outlet	LF	350				
605.11	12 Inch Underdrain Type C	LF	1,700				
606.13	31" W-Beam Guardrail – Mid-way Splice	LF	5,050				
606.1724	Bridge Transition - Type III Modified	EA	2				
606.278	Terminal End - Anchored End	EA	11				
606.279	Terminal End - Anchored End, Thrie Beam	EA	2				
606.352	Reflectorized Beam Guardrail Delineator	EA	9				
CARRIED FORWARD:							

Item No.	Item Description	Units	Approx. Quantities	Unit Prices in Numbers		Bid Amount in Numbers	
				Dollars	Cents	Dollars	Cents
BROUGHT FORWARD:							
606.353	Reflectorized Flexible Guardrail Marker	EA	32				
606.356	Underdrain Delineator Post	EA	189				
606.3562	Delineator Post - Remove and Stack	EA	119				
606.3605	Guardrail - Remove, Modify, and Reset, Single Rail	LF	25				
606.3610	Guardrail - Remove, Modify, and Reset Thrie Beam, Single Rail	LF	175				
606.3611	Guardrail - Remove, Modify, and Reset Thrie Beam, Double Rail	LF	700				
606.3631	Guardrail - Remove and Stack or Dispose	LF	10,050				
606.48	Single Galvanized Steel Post	EA	20				
606.64	Gr - Thrie Beam - Dbl Rail	LF	125				
606.65	Gr - Thrie Beam - Sgl Rail	LF	550				
606.754	Widen Shoulder for Energy Absorbing End Terminal	EA	12				
606.791	Guardrail – Flared Terminal – 31” W-Beam Guardrail (7’ Steel Posts, 8” Offset Blocks, Single Faced)	EA	13				
607.093	Right of Way Fencing with Habitat Barrier Fence, Metal Posts	LF	15,000				
CARRIED FORWARD:							

Item No.	Item Description	Units	Approx. Quantities	Unit Prices in Numbers		Bid Amount in Numbers	
				Dollars	Cents	Dollars	Cents
BROUGHT FORWARD:							
607.2325	Pipe Entry Gate	EA	1				
607.4	Chain Link Fence - 3' High	LF	480				
607.41	Post Assembly for Sign or Chain Link Fence	EA	67				
607.4211	Dumpster Enclosure	LS	1				
608.08	Reinforced Concrete Sidewalk/Site Concrete Slabs	SY	340				
608.26	Curb Ramp Detectable Warning Field	SF	75				
609.11	Vertical Curb Type 1	LF	1,700				
609.12	Vertical Curb Type 1 - Circular	LF	350				
609.238	Terminal Curb Type 1 - 8'	EA	8				
610.07	Stone Fill	CY	420				
610.08	Plain Riprap	CY	250				
610.181	Temporary Stone Check Dam	CY	400				
610.182	Permanent Stone Check Dam	CY	80				
CARRIED FORWARD:							

Item No.	Item Description	Units	Approx. Quantities	Unit Prices in Numbers		Bid Amount in Numbers	
				Dollars	Cents	Dollars	Cents
BROUGHT FORWARD:							
613.319	Erosion Control Blanket	SY	40,000				
615.07	Loam	CY	14,050				
618.13	Seeding Method Number 1	UN	850				
618.141	Seeding Method Number 3	UN	200				
619.1201	Mulch	UN	950				
619.1202	Temporary Mulch	LS	1				
619.13	Bark Mulch	CY	60				
620.56	Drainage Geotextile	SY	350				
620.58	Erosion Control Geotextile	SY	14,400				
621.037	Evergreen Tree (5'-6') Group GP A	EA	8				
621.291	Large Deciduous Tree (4" Cal) GP A	EA	1				
621.535	Deciduous Shrub (No. 3 Cont) GP A	EA	25				
625.086	2" Copper Tubing	LF	20				
CARRIED FORWARD:							

Item No.	Item Description	Units	Approx. Quantities	Unit Prices in Numbers		Bid Amount in Numbers	
				Dollars	Cents	Dollars	Cents
BROUGHT FORWARD:							
625.145	8" Non-Metallic Pipe Sleeve	LF	360				
625.16	2" Non-Metallic Pipe	LF	780				
626.111	Barrier Junction Box	EA	13				
626.113	4'x4' Splice Box	EA	12				
626.12	Quazite Junction Box (36x24)	EA	81				
626.13	Primary Electric Manholes (CMP)	EA	6				
626.22	Non-Metallic Conduit	LF	22,755				
626.2214	4" Non-Metallic Conduit, Concrete Encased	LF	6,500				
626.2215	5" Non-Metallic Conduit, Concrete Encased	LF	6,500				
626.3321	36-inch Diameter Drilled Shaft	LF	360				
626.3322	30-Inch Diameter Drilled Shaft - Rock Socket	LF	80				
626.341	Light Standard Foundation	EA	65				
627.18	12" Solid White Pavement Marking	LF	10,200				
CARRIED FORWARD:							

Item No.	Item Description	Units	Approx. Quantities	Unit Prices in Numbers		Bid Amount in Numbers	
				Dollars	Cents	Dollars	Cents
BROUGHT FORWARD:							
627.4072	Pref Pave Mark Tape Line, Groove Install	SF	2,000				
627.681	Temporary 6 Inch Painted Pavement Marking Line -Yellow or White	LF	140,000				
627.71	4" White Pavement Marking Line	LF	1,100				
627.731	Temporary 6 Inch Black Pavement Marking Tape	LF	2,000				
627.744	6" White or Yellow Painted Pavement Marking Line	LF	50,700				
627.75	White or Yellow Pavement & Curb Marking	SF	200				
627.77	Remove Existing Pavement Marking	SF	3,400				
627.73	Temporary 6 Inch Pavement Marking Tape	LF	3,200				
627.812	Temporary Raised Pavement Markers	EA	530				
627.9011	Pavement Marking Symbol	EA	9				
627.94	Pavement Marking Tape	LF	2,750				
629.05	Hand Labor, Straight Time	HR	20				
631.10	Air Compressor (Inc Operator)	HR	20				
CARRIED FORWARD:							

Item No.	Item Description	Units	Approx. Quantities	Unit Prices in Numbers		Bid Amount in Numbers	
				Dollars	Cents	Dollars	Cents
BROUGHT FORWARD:							
631.11	Air Tool (Inc Operator)	HR	20				
631.115	Jackhammer (Inc Operator)	HR	20				
631.12	All Purpose Excavator (Inc Operator)	HR	20				
631.171	Truck - Small (Including Operator)	HR	20				
631.18	Chain Saw Rental (Inc Operator)	HR	20				
631.32	Culvert Cleaner (Inc Operator)	HR	20				
631.36	Foreperson	HR	25				
631.51	Bucket Truck	HR	20				
631.52	Scissor Lift	HR	20				
631.53	Electrician	HR	20				
631.54	Electrician's Apprentice	HR	20				
633.021	Propane Service Line	LF	100				
634.16	Highway Lighting	LS	1				
CARRIED FORWARD:							

Item No.	Item Description	Units	Approx. Quantities	Unit Prices in Numbers		Bid Amount in Numbers	
				Dollars	Cents	Dollars	Cents
BROUGHT FORWARD:							
634.231	Conventional Light Standard with LED Fixture	EA	77				
634.232	Sign Light	EA	14				
639.18	Field Office Type A	EA	1				
639.19	Field Office Type B	EA	1				
641.35	Aluminum Flag Pole	EA	1				
643.63	Flashing Beacon - Solar Powered	EA	4				
643.712	Lane Use Signal	EA	9				
645.105	Remove and Stack Sign	EA	13				
645.1051	Remove and Stack Ground Mount Guide Sign and Structure	EA	4				
645.109	Remove and Reset Sign	EA	3				
645.1092	Canopy Mounted Dynamic Message Sign	EA	1				
645.121	Overhead Guide Sign 1 (Sta. 281+45)	LS	1				
645.122	Overhead Guide Sign 2 (Sta.306+65)	LS	1				
CARRIED FORWARD:							

Item No.	Item Description	Units	Approx. Quantities	Unit Prices in Numbers		Bid Amount in Numbers	
				Dollars	Cents	Dollars	Cents
BROUGHT FORWARD:							
645.123	Overhead Guide Sign 3 (Sta.318+81)	LS	1				
645.124	Overhead Guide Sign 4 (Sta.332+00)	LS	1				
645.125	Overhead Guide Sign 5 (Sta.359+50)	LS	1				
645.126	Overhead Guide Sign 6 (Sta.374+50)	LS	1				
645.127	Overhead Guide Sign 7 (Sta.382+50)	LS	1				
645.128	Overhead Guide Sign 8 (Sta.414+90)	LS	1				
645.14	Canopy Mounted Sign	EA	7				
645.141	Canopy Mounted DMS Remove and Reset	EA	1				
645.155	Variable Speed Limit Sign	EA	2				
645.251	Roadside Guide Signs, Type I	SF	1,462				
645.271	Regulatory, Warning, Confirmation and Route Assembly Sign, Type I	SF	490				
645.28	Wood Post	EA	26				
645.289	Steel H-Beam Poles	LB	13,400				
CARRIED FORWARD:							

Item No.	Item Description	Units	Approx. Quantities	Unit Prices in Numbers		Bid Amount in Numbers	
				Dollars	Cents	Dollars	Cents
BROUGHT FORWARD:							
645.501	Remove and Reset Mainline Sign 1	LS	1				
645.502	Remove and Reset Mainline Sign 2	LS	1				
645.503	Remove and Reset Mainline Sign 3	LS	1				
652.30	Flashing Arrow Board	EA	6				
652.312	Type III Barricade	EA	10				
652.33	Drum	EA	400				
652.34	Cone	EA	200				
652.35	Construction Signs	SF	1,450				
652.36	Maintenance of Traffic Control Devices	LS	1				
652.38	Flagger	HR	880				
652.41	Portable-Changeable Message Sign	EA	5				
652.45	Truck Mounted Attenuator	CD	500				
652.451	Automated Trailer Mounted Speed Limit Sign	EA	2				
CARRIED FORWARD:							

Item No.	Item Description	Units	Approx. Quantities	Unit Prices in Numbers		Bid Amount in Numbers	
				Dollars	Cents	Dollars	Cents
BROUGHT FORWARD:							
652.50	Temporary Barrier	LS	1				
655.01	Installation of ORT Lane Controller Cabinet	EA	2				
655.012	Installation of Cash Lane Controller Cabinet	EA	9				
655.02	DVAS Mount Installation	EA	13				
655.03	VCARS Mount Installation	EA	20				
655.04	Installation of Sensor Loops	LS	1				
655.05	Installation of AVI Antennas	EA	27				
655.06	Installation of AVI Readers	EA	6				
655.07	Traffic Control Pedestal Preparation Work	EA	9				
655.08	OPUS Mount Installation	EA	30				
655.09	Armored Cable - 10/3	LF	100				
655.100	#2/0 AWG Wire	LF	1,550				
655.1001	#1/0 AWG Wire	LF	1,000				
CARRIED FORWARD:							

Item No.	Item Description	Units	Approx. Quantities	Unit Prices in Numbers		Bid Amount in Numbers	
				Dollars	Cents	Dollars	Cents
BROUGHT FORWARD:							
655.1003	#3/0 AWG Wire	LF	3,500				
655.101	#1 AWG Wire	LF	5,000				
655.102	#2 AWG Wire	LF	1,150				
655.104	#4 AWG Wire	LF	100				
655.106	#6 AWG Wire	LF	100				
655.11	#10 AWG Wire	LF	4,850				
655.12	#12 AWG Wire	LF	80,000				
655.13	#14 AWG Wire	LF	1,000				
655.14	4pr/24 (Category 5e) Cable	LF	44,000				
655.15	LMR 400 Cable	LF	1,730				
655.16	Fiber Optic Cable – 6 Fiber	LF	3,390				
655.17	IVIS Homerun Loop Cable (IMSA 50-2 #14)	LF	11,350				
655.200	1 1/2" Schedule 40 PVC Conduit	LF	250				
CARRIED FORWARD:							

Item No.	Item Description	Units	Approx. Quantities	Unit Prices in Numbers		Bid Amount in Numbers	
				Dollars	Cents	Dollars	Cents
BROUGHT FORWARD:							
655.2001	3/4" Schedule 40 PVC Conduit	LF	200				
655.2002	1" Schedule 40 PVC Conduit	LF	200				
655.2003	2" Schedule 40 PVC Conduit	LF	400				
655.201	3" Schedule 40 PVC Conduit	LF	200				
655.202	4" Schedule 40 PVC Conduit	LF	750				
655.2021	1" Schedule 80 PVC Conduit	LF	400				
655.203	1 1/2" Schedule 80 PVC Conduit	LF	1,440				
655.2031	2" Schedule 80 PVC Conduit	LF	430				
655.204	3" Schedule 80 PVC Conduit	LF	3,000				
655.205	4" Schedule 80 PVC Conduit	LF	230				
655.2051	6" Schedule 80 PVC Conduit	LF	300				
655.2052	5" Schedule 80 PVC Conduit	LF	300				
655.206	1" Galvanized Rigid Metal Conduit	LF	900				
CARRIED FORWARD:							

Item No.	Item Description	Units	Approx. Quantities	Unit Prices in Numbers		Bid Amount in Numbers	
				Dollars	Cents	Dollars	Cents
BROUGHT FORWARD:							
655.2061	3/4" Galvanized Rigid Metal Conduit	LF	600				
655.207	1 1/2" Galvanized Rigid Metal Conduit	LF	350				
655.2071	2" Galvanized Rigid Metal Conduit	LF	600				
655.208	3" Galvanized Rigid Metal Conduit	LF	1,040				
655.209	1/2" Liquid Tight Metallic Flexible Conduit	LF	700				
655.210	3/4" Liquid Tight Metallic Flexible Conduit	LF	280				
655.2101	1 1/2" Liquid Tight Metallic Flexible Conduit	LF	100				
655.2102	2" Liquid Tight Metallic Flexible Conduit	LF	100				
655.2103	1" Liquid Tight Metallic Flexible Conduit	LF	100				
655.211	1 1/2" Electrical Metallic Tubing Conduit	LF	180				
655.2111	1" Electrical Metallic Tubing Conduit	LF	180				
655.212	2" Electrical Metallic Tubing Conduit	LF	180				
655.213	3" Electrical Metallic Tubing Conduit	LF	100				
CARRIED FORWARD:							

Item No.	Item Description	Units	Approx. Quantities	Unit Prices in Numbers		Bid Amount in Numbers	
				Dollars	Cents	Dollars	Cents
BROUGHT FORWARD:							
655.214	4" Electrical Metallic Tubing Conduit	LF	100				
655.215	3/4" Electrical Metallic Tubing Conduit	LF	100				
655.221	Type A Pull Box Inside	EA	36				
655.222	Type C Pull Box in Tunnel/Booth Pit	EA	40				
655.223	Type D Pull Box Outdoor Canopy	EA	4				
655.224	Type E Pull Box Steel in Booth	EA	18				
655.225	Type F Pull Box Outside	EA	13				
655.30	12" x 12" x 6" Galvanized Junction Box	EA	100				
655.31	18" x 18" x 6" Galvanized Junction Box	EA	8				
655.40	18" x 24" x 12" Junction Box	EA	6				
655.42	36" x 30" x 20" NEMA 4X Cabinet	EA	6				
655.43	60 AMP 3 Phase Panelboard Cabinet	EA	4				
655.44	100 AMP 3 Phase Panelboard Cabinets	EA	4				
CARRIED FORWARD:							

Item No.	Item Description	Units	Approx. Quantities	Unit Prices in Numbers		Bid Amount in Numbers	
				Dollars	Cents	Dollars	Cents
BROUGHT FORWARD:							
655.50	2" PVC Conduit Condulets	EA	20				
655.51	4" PVC Conduit Condulets	EA	20				
655.511	3/4" Rigid Metal Conduit Condulets	EA	10				
655.52	1" Rigid Metal Conduit Condulets	EA	50				
655.53	1½" Rigid Metal Conduit Condulets	EA	50				
655.54	2" Rigid Metal Conduit Condulets	EA	20				
655.55	3" Electrical Metal Tubing Condulets	EA	20				
655.56	2" Electrical Metal Tubing Condulets	EA	20				
655.57	1 1/2" Electrical Metal Tubing Condulets	EA	20				
655.58	3/4" Electrical Metal Tubing Condulets	EA	20				
655.59	1" Electrical Metal Tubing Condulets	EA	20				
655.63	4-inch x 4-inch PVC NEMA 3R Wireway	LF	630				
655.64	6-inch x 6-inch PVC NEMA 3R Wireway	LF	660				
CARRIED FORWARD:							

Item No.	Item Description	Units	Approx. Quantities	Unit Prices in Numbers		Bid Amount in Numbers	
				Dollars	Cents	Dollars	Cents
BROUGHT FORWARD:							
655.65	8-inch x 8-inch PVC NEMA 3R Wireway	LF	660				
655.66	12-inch x 12-inch PVC NEMA 3R Wireway	LF	400				
655.75	Concrete Encased Conduit	CY	60				
655.80	Lightning Suppression System	LS	1				
655.81	Key Switch	EA	18				
655.82	Duplex Receptacle	EA	20				
655.83	NEMA L5-30R Receptacle	EA	6				
655.84	Quadplex Receptacle	EA	30				
655.90	Space Frame Lighting	LS	1				
655.92	LED Canopy Light Fixture	EA	18				
655.98	Toll Booth Electrical Installation	LS	1				
655.99	LED Bumper Beacon	EA	9				
656.50	Baled Hay, In Place	EA	50				
CARRIED FORWARD:							

Item No.	Item Description	Units	Approx. Quantities	Unit Prices in Numbers		Bid Amount in Numbers	
				Dollars	Cents	Dollars	Cents
BROUGHT FORWARD:							
656.60	Temporary Berms	LF	150				
656.62	Temporary Slope Drains	LF	150				
656.632	30" Temporary Silt Fence	LF	24,000				
659.10	Mobilization	LS	1				
665.002	Communications	LS	1				
800.01	Toll Administration Building	LS	1				
800.22	HVAC Tunnel and Booths	LS	1				
800.23	Tunnel and Toll Stairway Lighting, Fire Alarm, and House Power	LS	1				
800.24	Toll Administration Building Standby Generator	LS	1				
800.40	Tunnel Stair Enclosures	LS	1				
800.41	Tunnel Access Hatch	LS	1				
800.501	Southbound and Northbound Plaza Canopies	LS	1				
800.503	Metal Stairs at Tunnel Staircases	LS	1				
CARRIED FORWARD:							

Item No.	Item Description	Units	Approx. Quantities	Unit Prices in Numbers		Bid Amount in Numbers	
				Dollars	Cents	Dollars	Cents
BROUGHT FORWARD:							
800.51	New Toll Booth Installation	LS	1				
800.62	Radon Mitigation System	LS	1				
801.03	Test Pits	EA	2				
801.132	2 Inch Force Main	LF	50				
801.141	4" PVC Sanitary Sewer (SDR-35)	LF	40				
802.23	Subsurface Wasterwater Leach Field With Geotextile Sand Filter (GSF)	LS	1				
802.241	1250 Gallon Precast Septic Tank with Pump	LS	1				
822.37	16" Ductile Iron Pipe	LF	1,660				
822.60	Water Meter Pit	LS	1				
823.3411	1" Air Release Valve	EA	1				
823.374	16" Gate Valve	EA	2				
832.41	Type A Steel Site Bollard	EA	9				
TOTAL:							

Date: 10/14/2018

Filename: ... \00259637.003_Estimate_01.dgn

Item No.	Item Description	Unit	Quantity
201.11	Clearing	AC	17
202.15	Rem Manhole Or Catch Basin	EA	22
202.151	Abandoning Existing Manhole or Catch Basin	EA	10
202.16	Removing Existing Pipe	LF	575
202.161	Abandoning Existing Pipe	LF	680
202.202	Removing Pavement Surface	SY	88,000
202.205	Rumble Strips - Shoulder	LF	35,500
202.206	Removing Rumble Strips	LF	6,100
202.60	Abandon Monitoring Well	EA	2
203.20	Common Excavation	CY	128,500
203.21	Rock Excavation	CY	47,300
203.211	Presplitting Rock	LF	400
203.213	Shatter Solid Rock Subgrade	SY	5,700
203.24	Common Borrow	CY	41,500
203.245	Clay Borrow	CY	55
203.25	Granular Borrow	CY	5,410
203.35	Crushed Stone Fill 3/4-Inch	CY	550
205.51	Widening of Existing Shoulder	SY	315
206.07	Structural Rock Excavation - Drainage & Minor Structures	CY	4,100
206.082	Structural Earth Excavation - Major Structures, Plan Quantity	CY	2,450
206.092	Structural Rock Excavation - Major Structures	CY	1,980
304.10	Aggr Subbase Course - Gravel	CY	115,500
304.14	Aggregate Base Course - Type A	CY	26,170
304.15	Aggregate Base Course - Type B	CY	200
403.207	Hot Mix Asphalt 19.0 mm Nominal Maximum Size	T	39,750
403.208	Hot Mix Asphalt 12.5 mm HMA Surface	T	550
403.2081	Hot Mix Asphalt - 12.5 mm Nominal Maximum Size (Polymer Modified)	T	14,300
403.209	Hot Mix Asphalt 9.5 mm (Incidentals)	T	50
403.211	Hot Mix Asphalt (Shim)	T	11,500
403.213	Hot Mix Asphalt 12.5 mm Base	T	14,240
409.15	Bituminous Tack Coat - Applied	G	17,675
419.30	Saw Cutting Bituminous Pavement	LF	3,600
502.231	Structural Concrete, Space Frame and Overhead Sign Structure Pedestals	CY	155
502.233	Structural Concrete, Canopy Column Foundations	CY	55
502.265	Structural Concrete, ORT Slabs	CY	300
502.266	Structural Concrete, Plaza Structural Slabs	CY	470
502.267	Structural Concrete, Toll Islands	CY	290
502.268	Structural Concrete, Utility Pits	CY	60
502.269	Structural Concrete, CCTV Pole Foundations	CY	14
502.28	Structural Concrete, Rigid Frame Structures [Tunnel]	CY	170
503.14	Epoxy-Coated Reinforcing Steel, Fabricated and Delivered	LB	136,500
503.15	Epoxy-Coated Reinforcing Steel, Placing	LB	136,500
503.18	Glass Fiber Reinforced Polymer (GFRP) Reinforcing Bars, Fabricated and Deliv.	LB	48,000
503.19	Glass Fiber Reinforced Polymer (GFRP) Reinforcing Bars, Placing	LB	48,000
503.90	Synthetic Fiber Reinforcement	LB	2,100
504.80	Space Frame Canopies, Fabricated and Delivered	LS	1
504.81	Space Frame Canopies, Erection	LS	1
504.90	Space Frame Steel Support Posts and Anchorage Assemblies	LS	1
504.91	Mounting Bracket Assemblies	LS	1
506.15	Shop Coating of New Steel	LS	1
506.9103	Galvanizing	LS	1
508.14	High Performance Waterproofing Membrane	SY	1,670
508.15	Membrane Waterproofing	LS	1
511.091	Temporary Earth Support Systems	LS	1
515.2011	Pigmented Concrete Protective Coating - Tunnel Walls & Ceiling	SY	1,330
515.2012	Pigmented Concrete Protective Coating - Tunnel Floor	SY	455
515.202	Clear Protective Coating for Concrete Surfaces	SY	1,400
515.23	Epoxy Overlay	SY	250
526.306	Temporary Concrete Barrier Type I - Supplied by the Authority	LS	1
526.351	Median Barrier Type I - Precast	LF	7,000
526.3511	Median Barrier Type IA - Precast	LF	1,800
526.3512	Median Barrier Type IB - Precast	LF	870
526.352	Median Barrier Type II - Precast	LF	240
526.3522	Median Barrier Type II - Cast in Place	LF	140

Item No.	Item Description	Unit	Quantity
526.3531	Median Barrier Type IIIA - Precast	LF	180
526.3532	Median Barrier Type IIIB - Precast	LF	180
526.361	Median Barrier Transition Type I - Precast	EA	4
526.3611	Median Barrier Transition Type IA - Precast	EA	2
526.3612	Median Barrier Transition Type IB - Precast	EA	2
526.3613	Median Barrier Transition Type LP-A	EA	8
526.3614	Median Barrier Transition Type LP-B	EA	10
526.362	Median Barrier Transition Type II - Precast	EA	16
526.371	Median Barrier With Mounted Light Pole Type LP-A	EA	4
526.372	Median Barrier With Mounted Light Pole Type LP-B	EA	5
527.306	Center Barrier Crash Attenuator	EA	2
527.341	Work Zone Crash Cushions - TL-3	UNIT	5
534.71	Precast Concrete Tunnel and Tunnel Staircase Structures	LS	1
603.155	12 Inch Reinforced Concrete Pipe Class III	LF	420
603.159	12 Inch Culvert Pipe Option III	LF	250
603.165	15 Inch Reinforced Concrete Pipe Class III	LF	2,375
603.169	15 Inch Culvert Pipe Option III	LF	450
603.175	18 Inch Reinforced Concrete Class III	LF	940
603.179	18 Inch Culvert Pipe Option III	LF	100
604.199	24 Inch Culvert Pipe Option III	LF	25
603.205	30 Inch Reinforced Concrete Class III	LF	64
603.215	36 Inch Reinforced Concrete Class III	LF	64
603.2353	48 Inch Reinforced Concrete Class V	LF	200
603.28	Concrete Collar for Reinforced Concrete Pipe	EA	10
603.90	12 Inch Ductile Iron Storm Drain	LF	90
604.09	Catch Basin Type B1	EA	24
604.0901	Catch Basin Type B1 with Flat Top	EA	48
604.152	48 Inch Manhole	EA	7
604.1542	72 Inch Outlet Control Structure	EA	5
604.1561	96 Inch Doghouse Manhole	EA	1
604.1581	Inlet Control Structure	EA	1
604.26	Catch Basin Type B5	EA	13
605.09	6 Inch Underdrain Type B	LF	1,450
605.105	8 Inch Underdrain Outlet	LF	350
605.11	12 Inch Underdrain Type C	LF	1,700
606.13	31" W-Beam Guardrail - Mid-way Splice	LF	5,050
606.1724	Guardrail Transition - Type 3	EA	2
606.278	Terminal End - Anchored End	EA	11
606.279	Terminal End - Anchored End, Thrie Beam	EA	2
605.352	Reflectorized Beam Guardrail Delineator	EA	9
606.353	Reflectorized Flexible Guardrail Marker	EA	32
606.356	Underdrain Delineator Post	EA	189
606.3562	Delineator Post - Remove and Stack	EA	119
606.3605	Guardrail - Remove, Modify, and Reset, Single Rail	LF	25
606.3610	Guardrail - Remove, Modify, and Reset Thrie Beam, Single Rail	LF	175
606.3611	Guardrail - Remove, Modify, and Reset Thrie Beam, Double Rail	LF	700
606.3631	Guardrail - Remove and Stack or Dispose	LF	10,050
606.48	Single Galvanized Steel Post	LF	20
606.64	Guardrail - Thrie Beam - Double Rail	LF	125
606.65	Gr - Thrie Beam - Sgl Rail	LF	550
606.754	Widen Shoulder for Energy Absorbing End Terminal	EA	12
606.791	Guardrail - Flared Terminal - 31" W-Beam Guardrail (7' Steel Posts, 8" Offset Blocks)	EA	13
607.093	Right of Way Fencing with Habitat Barrier Fence, Metal Posts	LF	15,000
607.2325	Pipe Entry Gate	EA	1
607.4	Chain Link Fence - 3' High	LF	480
607.41	Post Assembly for Sign or Chain Link Fence	EA	67
607.4211	Dumpster Enclosure	LS	1
608.08	Reinforced Concrete Sidewalk/Site Concrete Slabs	SY	340
608.26	Curb Ramp Detectable Warning Field	SF	75
609.11	Vertical Curb Type 1	LF	1,700
609.12	Vertical Curb Type 1 - Circular	LF	350
609.238	Terminal Curb Type 1 - 8'	EA	8
610.07	Stone Fill	CY	420

Item No.	Item Description	Unit	Quantity
610.08	Plain Riprap	CY	250
610.181	Temporary Stone Check Dam	CY	400
610.182	Permanent Stone Check Dam	CY	80
613.319	Erosion Control Blanket	SY	40,000
615.07	Loam	CY	14,050
618.13	Seeding Method Number 1	UN	850
618.141	Seeding Method Number 3	UN	200
619.1201	Mulch	UN	950
619.1202	Temporary Mulch	LS	1
619.13	Bark Mulch	CY	60
620.56	Drainage Geotextile	SY	350
620.58	Erosion Control Geotextile	SY	14,400
621.037	Evergreen Tree (5'-6') Group GP A	EA	8
621.291	Large Deciduous Tree (4" Cal) GP A	EA	1
621.535	Deciduous Shrub (No. 3 Cont) GP A	EA	25
625.086	2 Inch Copper Tubing	LF	20
625.145	8 Inch Non-Metallic Pipe Sleeve	LF	360
625.16	2 Inch Non-Metallic Pipe	LF	780
626.111	Barrier Junction Box	EA	13
626.113	4'x4' Splice Box	EA	12
626.12	Quazite Junction Box (36x24)	EA	81
626.13	Primary Electric Manholes (CMP)	EA	6
626.22	Non-Metallic Conduit	LF	22,755
626.2214	4" Non-Metallic Conduit, Concrete Encased	LF	6,500
626.2215	5" Non-Metallic Conduit, Concrete Encased	LF	6,500
626.3321	36-inch Diameter Drilled Shaft	LF	360
626.3322	30-Inch Diameter Drilled Shaft - Rock Socket	LF	80
626.341	Light Standard Foundation	EA	65
627.18	12" Solid White Pavement Marking	LF	10,200
627.4072	Pref Pave Mark Tape Line, Groove Install	SF	2,000
627.71	4" White Pavement Marking Line	LF	1,100
627.73	Temporary 6 Inch Pavement Marking Tape	LF	3,200
627.731	Temporary 6 Inch Black Pavement Marking Tape	LF	2,000
627.744	6 Inch White or Yellow Pavement Marking Line	LF	50,700
627.75	White or Yellow Pavement & Curb Marking	SF	200
627.77	Remove Existing Pavement Marking	SF	3,400
627.781	Temporary 6 Inch Painted Pavement Marking Line -Yellow or White	LF	140,000
627.812	Temporary Raised Pavement Markers	EA	530
627.9011	Pavement Marking Symbol	EA	9
627.94	Pavement Marking Tape	LF	2,750
629.05	Hand Labor, Straight Time	HR	20
631.10	Air Compressor (Inc Operator)	HR	20
631.11	Air Tool (Inc Operator)	HR	20
631.115	Jackhammer (Inc Operator)	HR	20
631.12	All Purpose Excavator (Inc Operator)	HR	20
631.171	Truck - Small (Including Operator)	HR	20
631.18	Chain Saw Rental (Inc Operator)	HR	20
631.32	Culvert Cleaner (Inc Operator)	HR	20
631.36	Foreperson	HR	25
631.51	Bucket Truck	HR	20
631.52	Scissor Lift	HR	20
631.53	Electrician	HR	20
631.54	Electrician's Apprentice	HR	20
633.021	Propane Service Line	LF	100
634.16	Highway Lighting	LS	1
634.231	Conventional Light Standard with LED Fixture	EA	77
634.232	Sign Light	EA	14
639.18	Field Office Type A	EA	1
639.19	Field Office Type B	EA	1
641.35	Aluminum Flag Pole	EA	1
643.63	Flashing Beacon - Solar Powered	EA	4
643.712	Lane Use Signal	EA	9
645.105	Remove and Stack Sign	EA	13

Scale: **NO SCALE**

No.	Revision	By	Date
1	Remove Item 203.24	CSM	9/18
2	Add Items 203.211, 634.231, 634.232	CSM	10/18

Designed by:



CONSULTANT PROJECT MANAGER: T. MORIN

By	Date	By	Date
Designed	CSM 7\18	Checked	RRP 7\18
Drawn	AMS 7\18	In Charge of	TWM 7\18

JACOBS ENGINEERING GROUP
 120 ST. JAMES AVENUE
 BOSTON, MA 02116
 TEL (617) 242-9222
 FAX (617) 242-9824



THE GOLD STAR MEMORIAL HIGHWAY

MTA PROJECT MANAGER: R. NORWOOD

YORK TOLL PLAZA

ESTIMATED QUANTITIES 1

SHEET NUMBER: QN-01

CONTRACT: 2018.20

3 OF 489

Date:10/14/2018

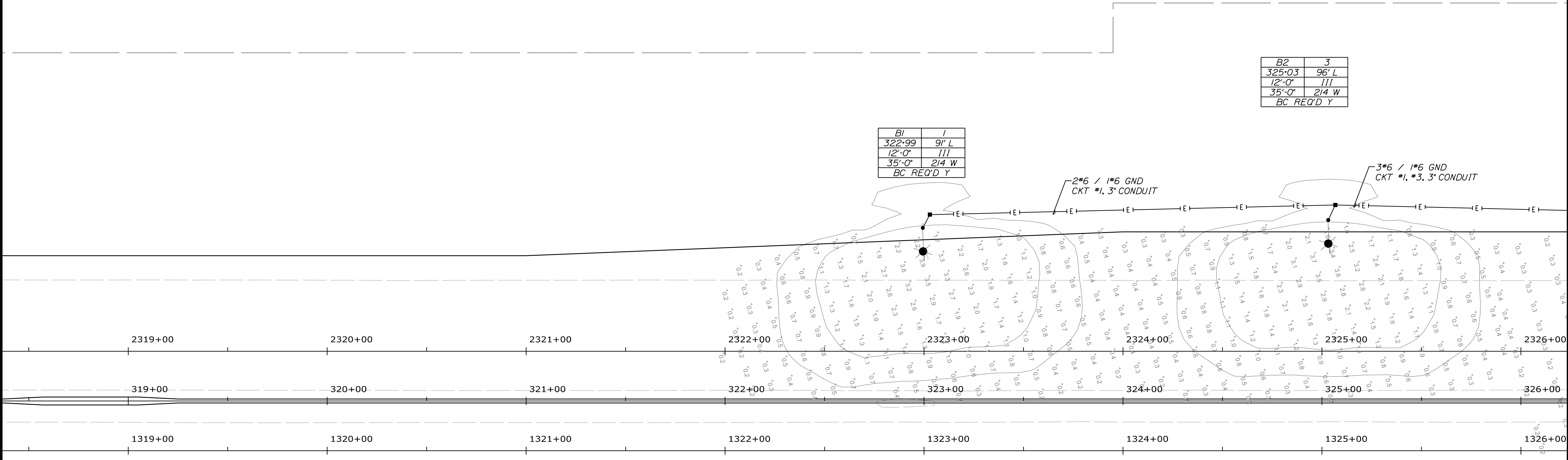
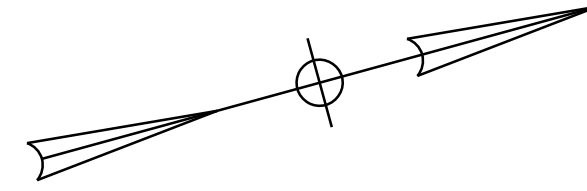

B2	3
325-03	96' L
12'-0"	111
35'-0"	214 W
BC REQ'D Y	

BI	1
322-99	91' L
12'-0"	111
35'-0"	214 W
BC REQ'D Y	

LEGEND

POLE #	CKT #
BI	I
STATION	OFFSET
250-XX	XX' L
ARM LENGTH	DISTRIBUTION
6'-0"	III
MOUNTING HEIGHT	LUMINAIRE WATTAGE
30'-0"	177 W
BREAKAWAY COUPLING (BC) REQUIRED Y/N	
BC REQ'D Y	

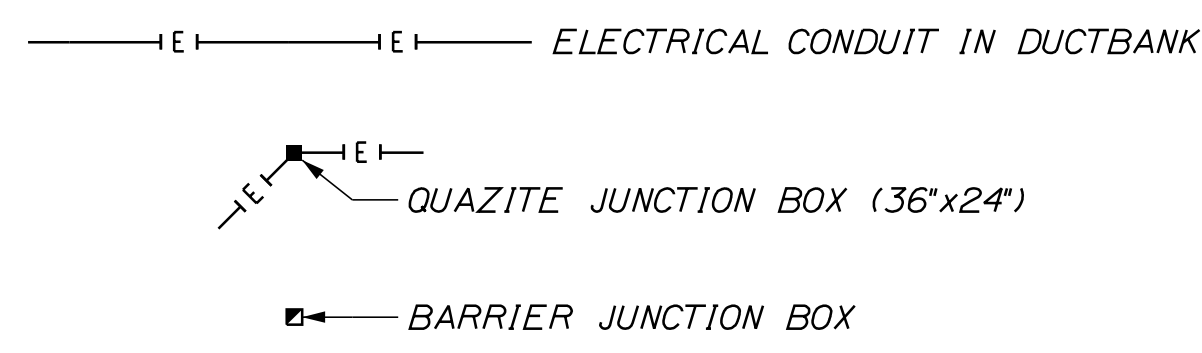

- A 'A' INDICATES LUMINAIRE LABEL, SEE LUMINAIRE SCHEDULE ON SHEET LT-15.
- STREET LIGHT, POLE MATERIAL, STEEL, WITH ARM AND COBRAHEAD LIGHT FIXTURE
- STREET LIGHT, POLE MATERIAL, STEEL, WITH (2) ARM AND COBRAHEAD LIGHT FIXTURE
- LUMINAIRE TEMPLATE - 0.5 fc & 1.0 fc (SINGLE LIGHT SOURCE)
- RESULTANT ILLUMINANCE MEASURED IN FOOT CANDLES (ALL LIGHT SOURCES)

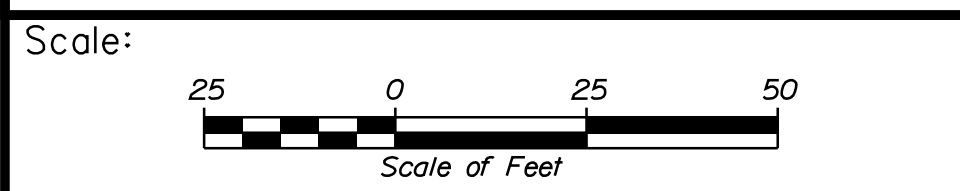

Designed by:

JACOBS

CONSULTANT PROJECT MANAGER: T. MORIN

By	Date	By	Date
Designed PV	7/18	Checked DB	7/18
Drawn SMG	7/18	In Charge of TW	7/18

JACOBS ENGINEERING GROUP
120 ST. JAMES AVENUE
BOSTON, MA. 02116
TEL (617) 242-9222
FAX (617) 242-9824

THE GOLD STAR MEMORIAL HIGHWAY

MTA PROJECT MANAGER: R. NORWOOD

YORK TOLL PLAZA

LIGHTING PLAN 1

SHEET NUMBER: LT-01

152 OF 489

CONTRACT:2018.20

Filename: ...d0272284\152_L1Plan1.dgn

Date:10/14/2018

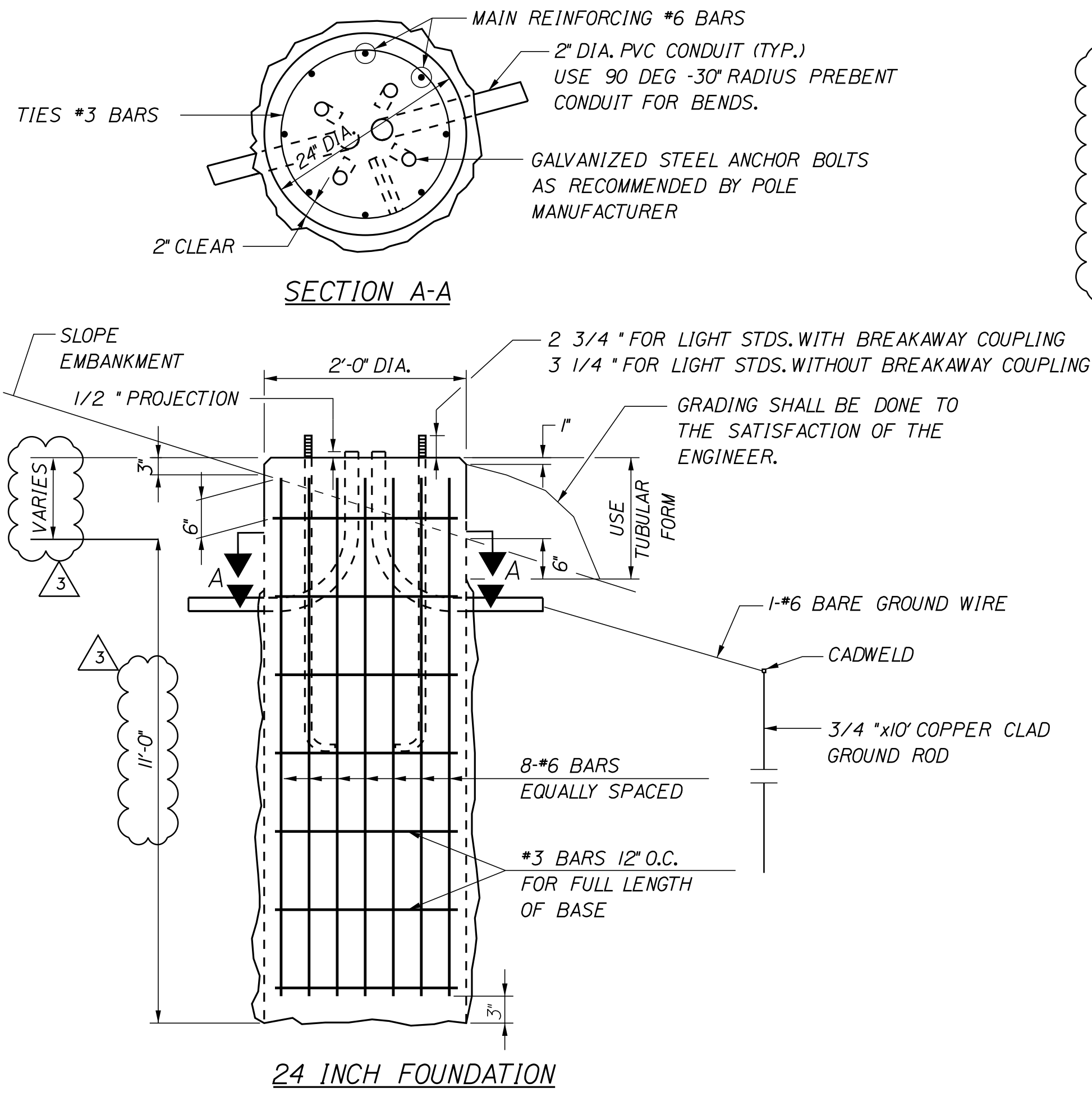

- NOTES:**
- WHERE SOLID ROCK IS ENCOUNTERED AT LESS THAN THE REQUIRED DISTANCE BELOW GROUND LEVEL, REINFORCING STEEL SHALL BE DOWELED INTO LEDGE AS SHOWN ON MAINE DOT STANDARD DETAIL 626(06). PAYMENT SHALL BE INCIDENTAL TO THE FOUNDATION PAY ITEM.
 - GROUNDING SYSTEM SHALL BE THE SAME FOR ITS CCTV POLES.

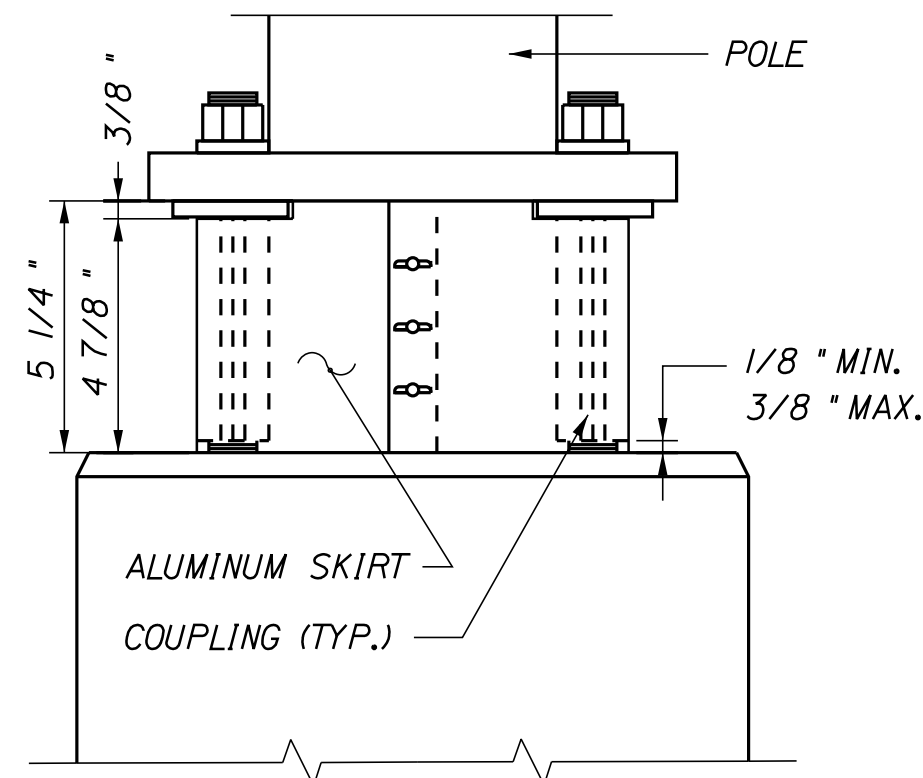

BREAKAWAY COUPLINGS AND SKIRT DETAIL
NOT TO SCALE

* BREAKAWAY COUPLINGS SHALL BE REQUIRED ON ALL NEW LIGHT STANDARDS

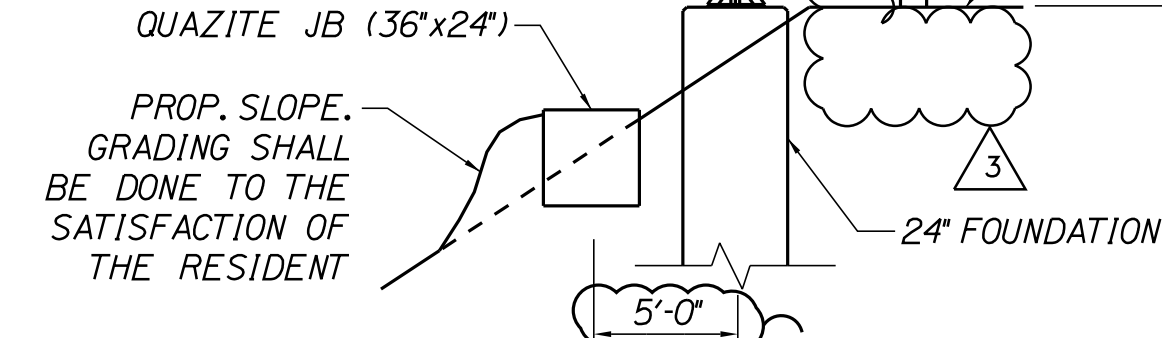
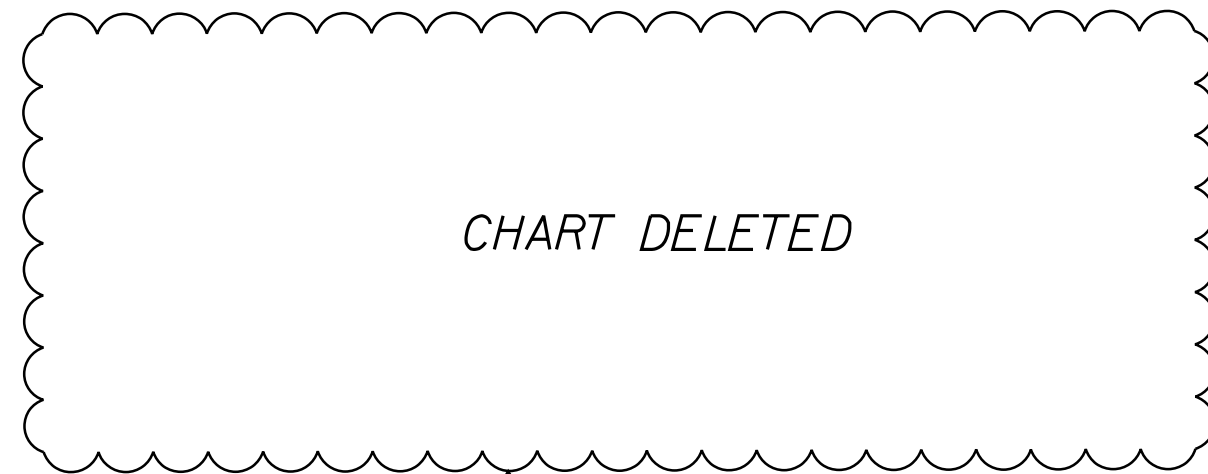

PLACEMENT OF LIGHT STANDARD
NO SCALE

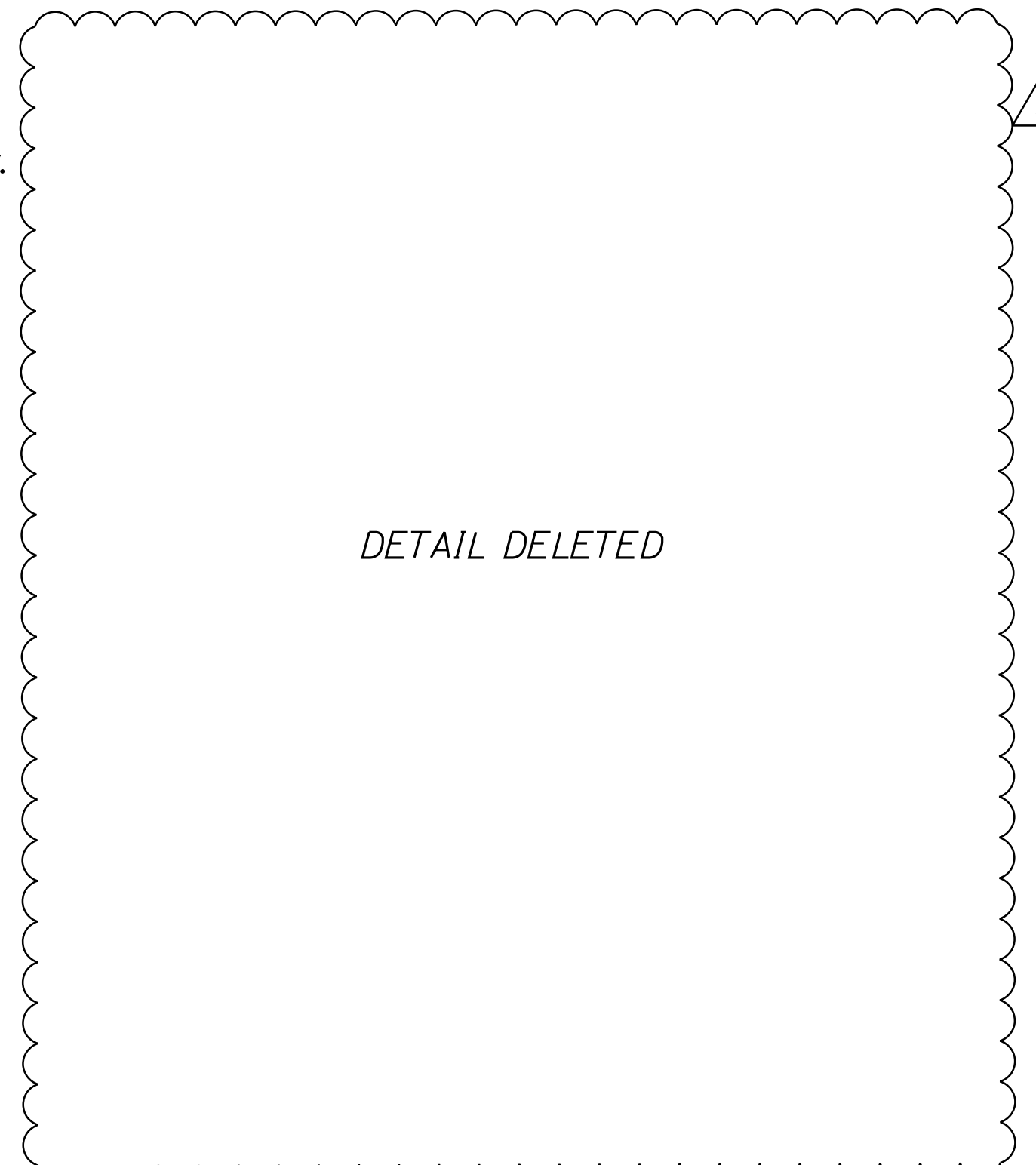

DETAIL DELETED

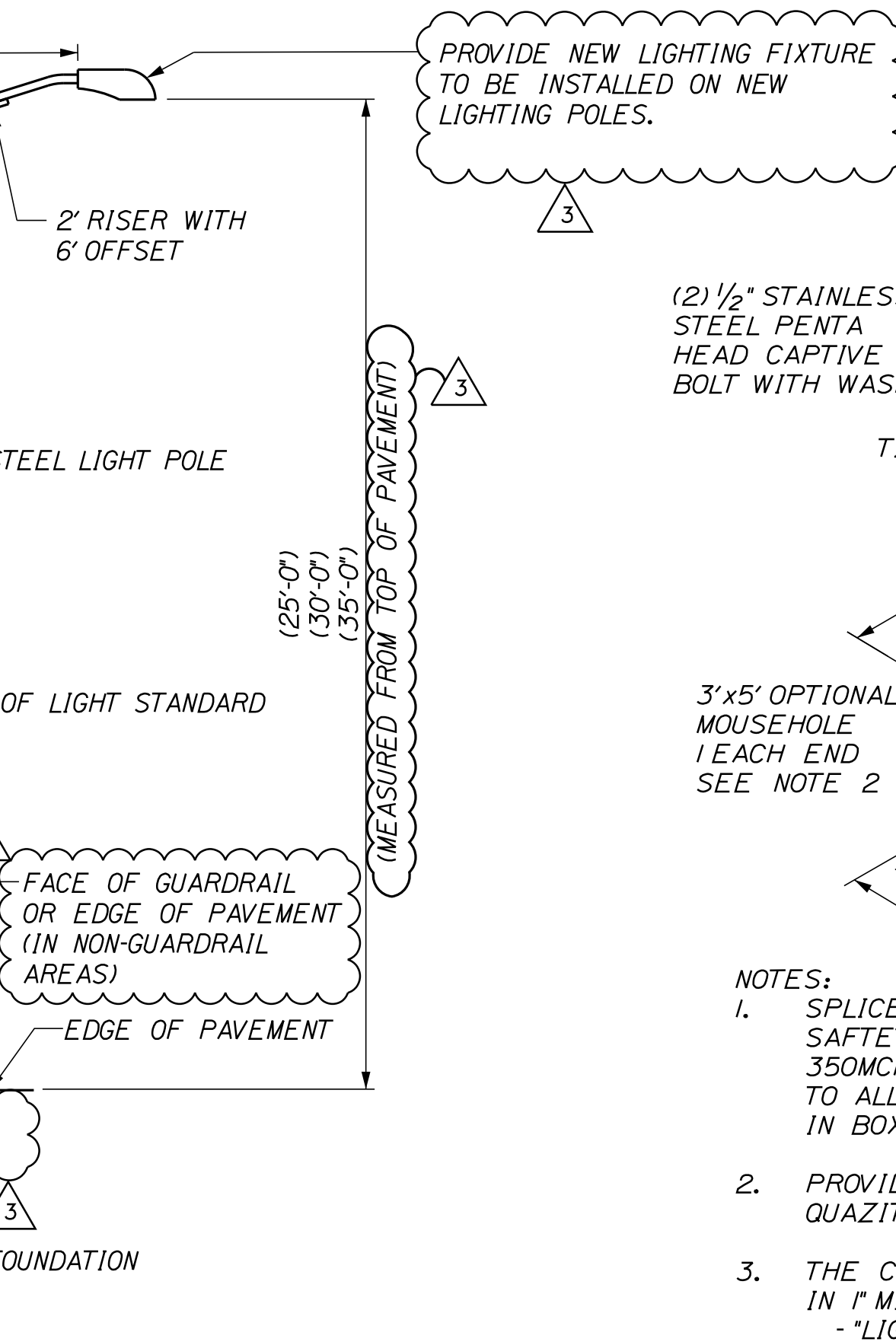

TRENCH CROSS SECTION
NOT TO SCALE

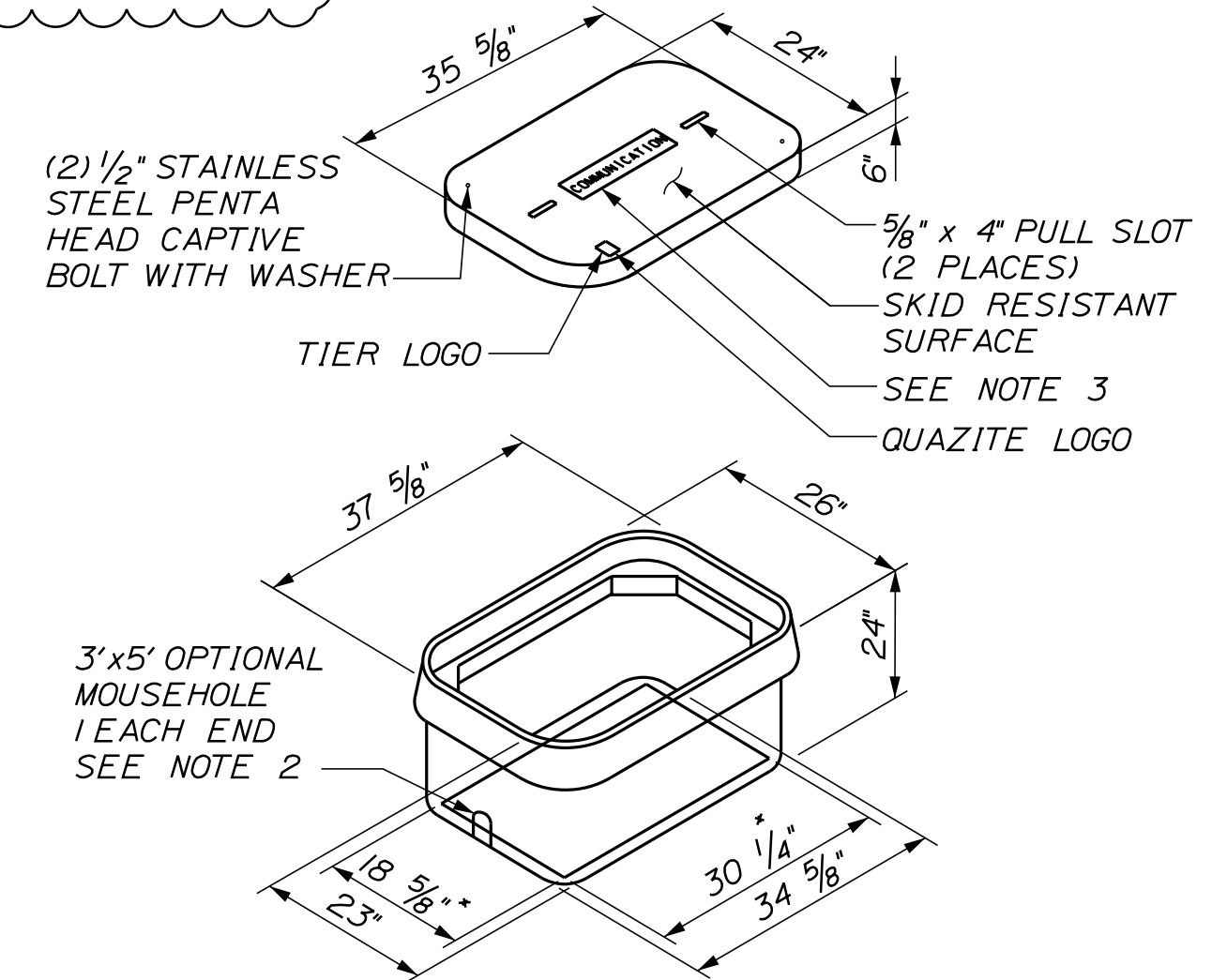

- NOTES:**
- SPLICES IN BOX SHALL BE MADE WITH ILSPP USPA-350-SS-DB SAFTEYSUB WATER TIGHT DIRECT BURY SPLICE WIRE RANGE 350MCM-10-STR, ONLY. PROVIDE ENOUGH SLACK IN THE WIRE TO ALLOW REMOVAL OF SPLICES AND NEATLY ARRANGE WIRE IN BOX.
 - PROVIDE 12" CRUSHED STONE UNDER BOX (INCIDENTAL TO QUAZITE BOX ITEM).
 - THE COVER SHALL BE LABELED WITH THE FUNCTION DESIGNATION IN 1" MIN TEXT AS FOLLOWS:
- "LIGHTING" FOR LIGHTING CONDUIT
- "COMMUNICATION" FOR COMMUNICATIONS CONDUIT
- "ELECTRICAL" FOR TOLLING SYSTEM ELECTRICAL AND NON-LIGHTING GENERAL ELECTRICAL.
 - DIMENSIONS SHOWN FOR ITEM 626.12 QUAZITE JUNCTION BOX (36X24). SEE MANUFACTURERS DETAILS FOR DIMENSIONS OF ITEM.
* BOTTOM OPENING

QUAZITE JUNCTION BOX (36X24) DETAIL
NOT TO SCALE

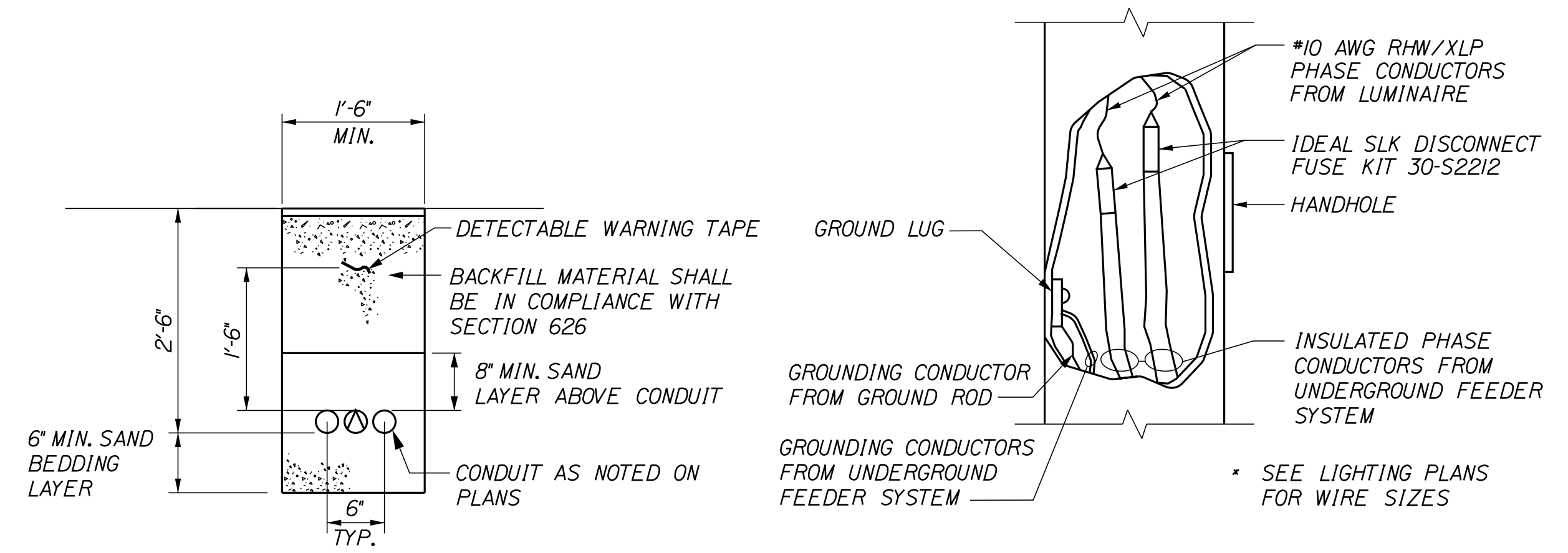

TYPICAL POLE WIRING DETAIL
NOT TO SCALE

Filename: ...\\165_L114 - Typical_01_Lighting.dgn

Scale: AS NOTED			
No.	Revision	By	Date
3	Addendum 3 - Revised Details and Charts	PV	10/18

Designed by: JACOBS					
CONSULTANT PROJECT MANAGER: T. MORIN					
Designed	PV	7/18	Checked	DB	7/18
Drawn	EFG	7/18	In Charge of	TWM	7/18

JACOBS ENGINEERING GROUP
120 ST. JAMES AVENUE
BOSTON, MA. 02116
TEL (617) 242-9222
FAX (617) 242-9824



THE GOLD STAR MEMORIAL HIGHWAY

MTA PROJECT MANAGER: R. NORWOOD

YORK TOLL PLAZA
LIGHTING DETAILS

SHEET NUMBER: LT-14
CONTRACT:2018.20
165 OF 489

Date: 10/14/2018

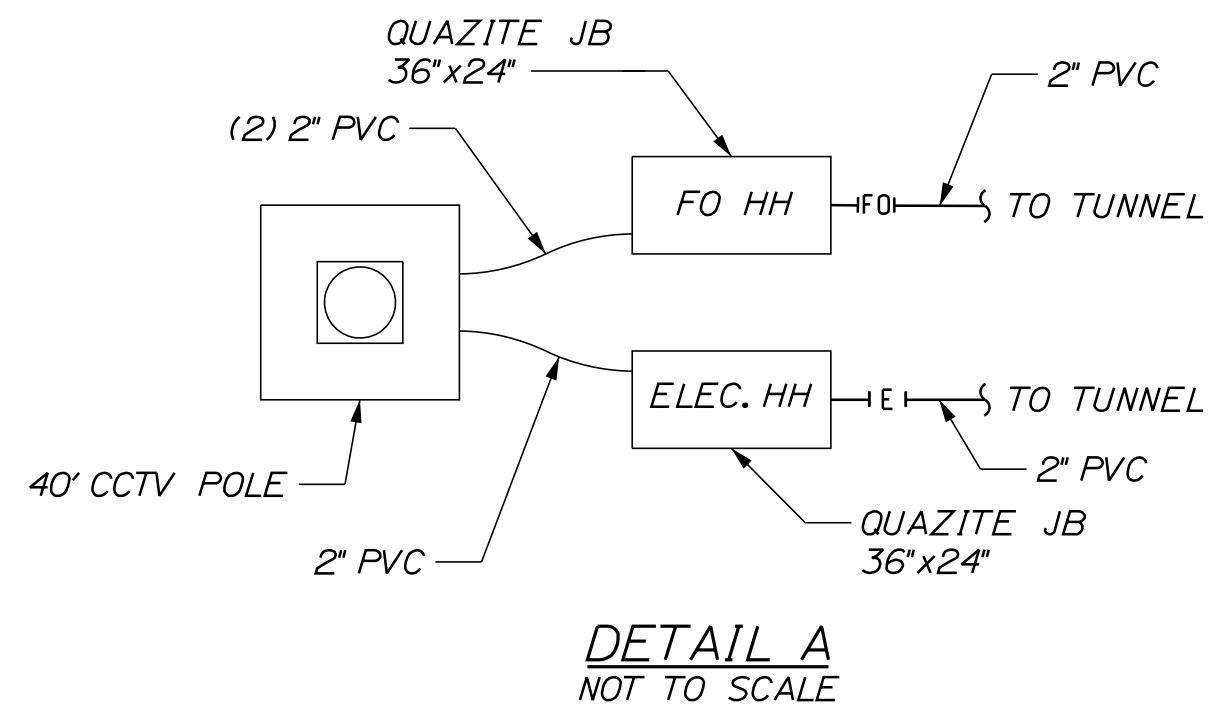
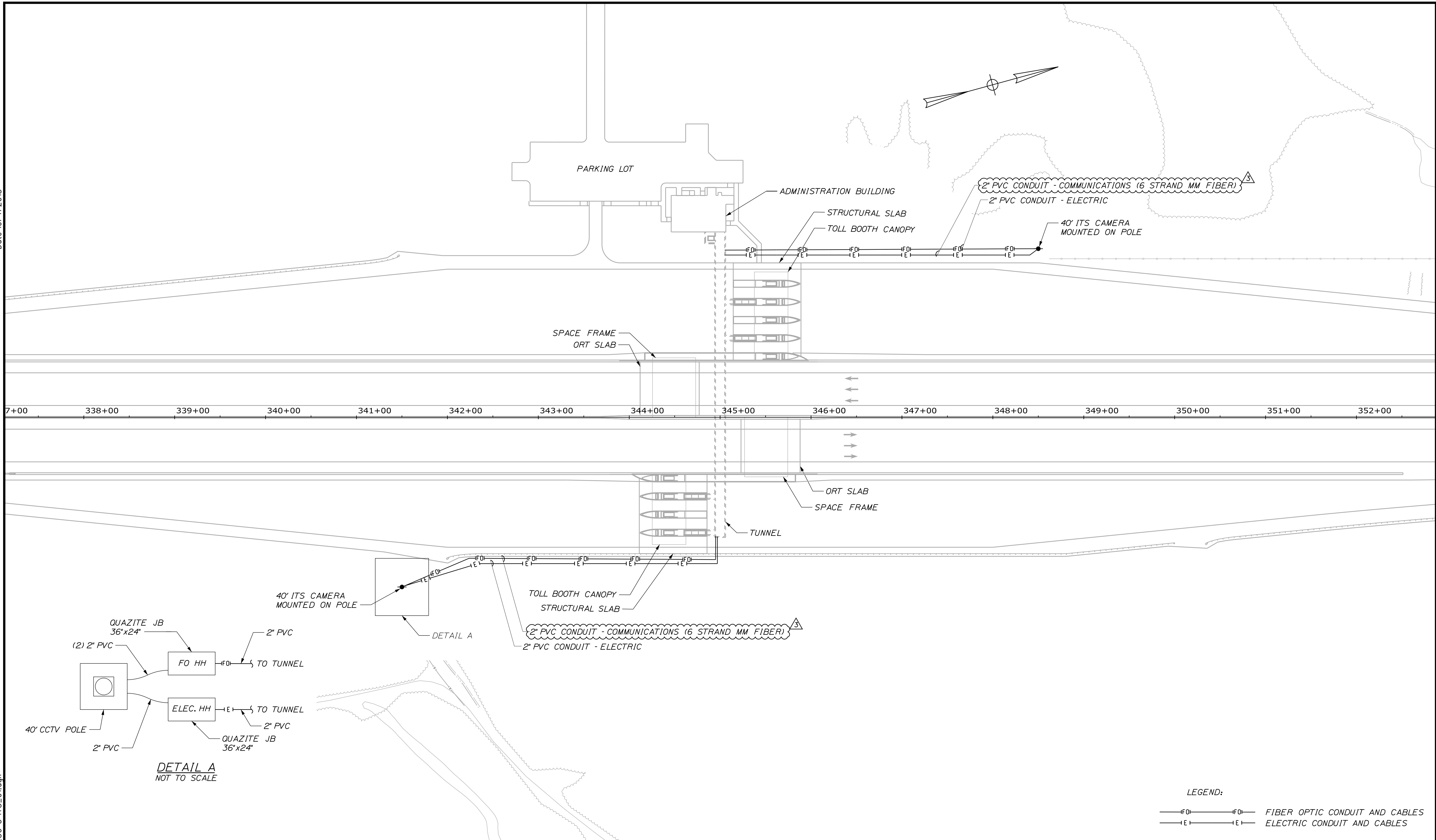

LEGEND:
 —FO— —FO— FIBER OPTIC CONDUIT AND CABLES
 —E— —E— ELECTRIC CONDUIT AND CABLES

Filename: ... \0272276\455_SC-5-ITS_01.dgn

Scale: Scale of Feet

No.	Revision	By	Date
3	Addendum 3 - Revised Fiber Optic Cable Designation	JD	10/18

Designed by:

JACOBS®

CONSULTANT PROJECT MANAGER: T. MORIN

	By	Date	Checked	By	Date
Designed	JD	7/18		CJC	7/18
Drawn	EFG	7/18	In Charge of	TWM	7/18

JACOBS ENGINEERING GROUP
 120 ST. JAMES AVENUE
 BOSTON, MA. 02116
 TEL (617) 242-9222
 FAX (617) 242-9824

THE GOLD STAR MEMORIAL HIGHWAY

MTA PROJECT MANAGER: R. NORWOOD

YORK TOLL PLAZA

ITS PLANS - CCTV
GENERAL PLAN AT TOLL PLAZA

SHEET NUMBER: SC-5
455 OF 489

CONTRACT: 2018.20

Date: 10/14/2018

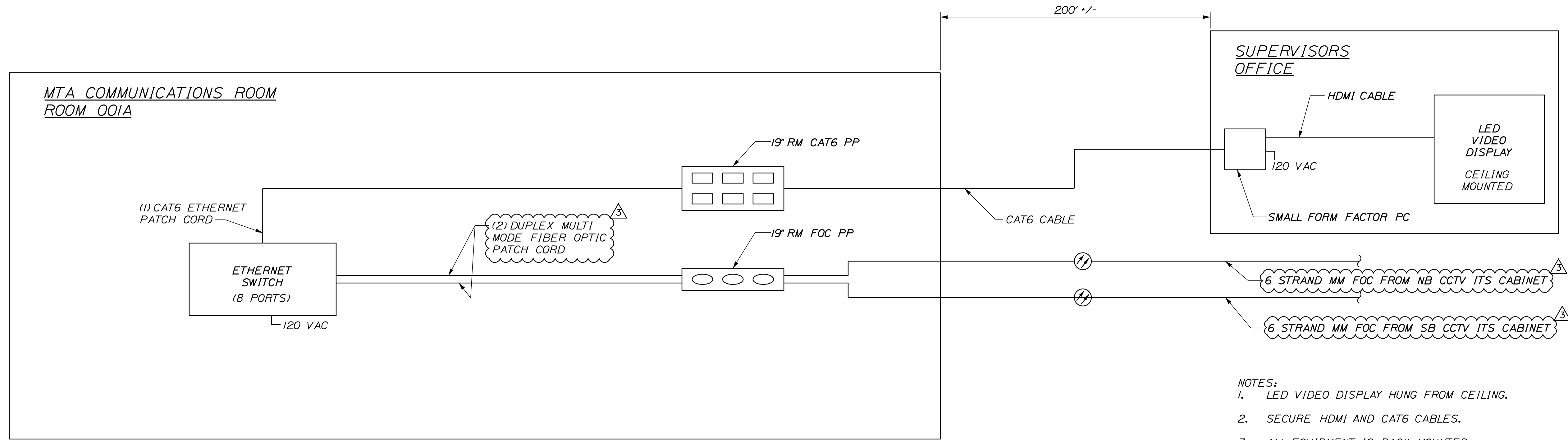
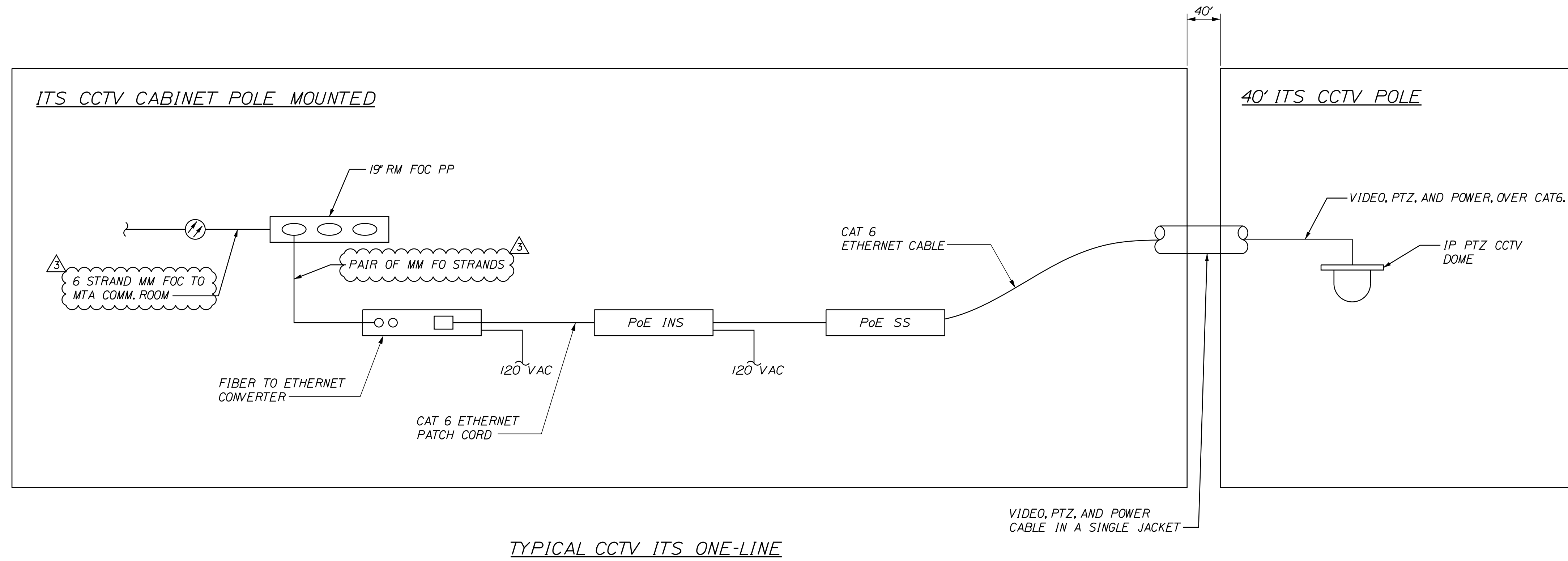

- NOTES:
1. LED VIDEO DISPLAY HUNG FROM CEILING.
 2. SECURE HDMI AND CAT6 CABLES.
 3. ALL EQUIPMENT IS RACK MOUNTED.
 4. FOR POWER CONNECTIONS SEE ELECTRICAL DETAILS.
 5. ALL CCTV EQUIPMENT SHALL BE CONNECTED TO LOCAL UPS.

Filename: ...V456_SC-6 CCTV ITS ONE-LINE.dgn

Scale:

No.	Revision	By	Date
3	Addendum 3 - Revised Fiber Optic Cable Designation	JD	10/18

Designed by:

JACOBS

CONSULTANT PROJECT MANAGER: T. MORIN

	By	Date	By	Date	
Designed	JD	7/18	Checked	CJC	7/18
Drawn	EFG	7/18	In Charge of	TWM	7/18

JACOBS ENGINEERING GROUP
 120 ST. JAMES AVENUE
 BOSTON, MA. 02116
 TEL (617) 242-9222
 FAX (617) 242-9824

MAINE TURNPIKE

THE GOLD STAR MEMORIAL HIGHWAY

MTA PROJECT MANAGER: R. NORWOOD

YORK TOLL PLAZA

CCTV ITS ONE-LINE DIAGRAM

SHEET NUMBER: SC-6

CONTRACT: 2018.20

456 OF 489

Date: 10/14/2018

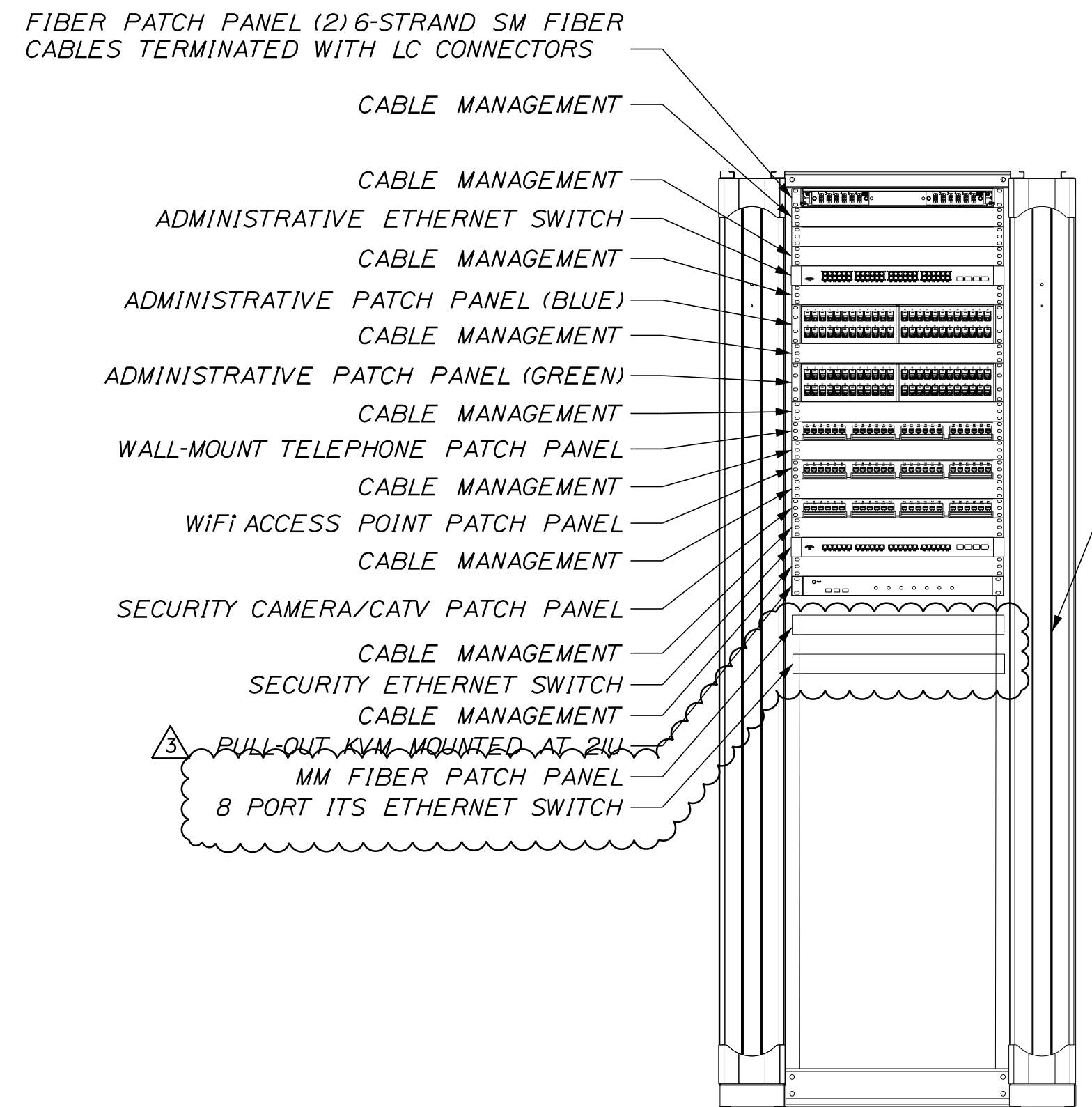

ZERO-V POWER DISTRIBUTION UNIT MOUNTED IN REAR (NOT SHOWN)

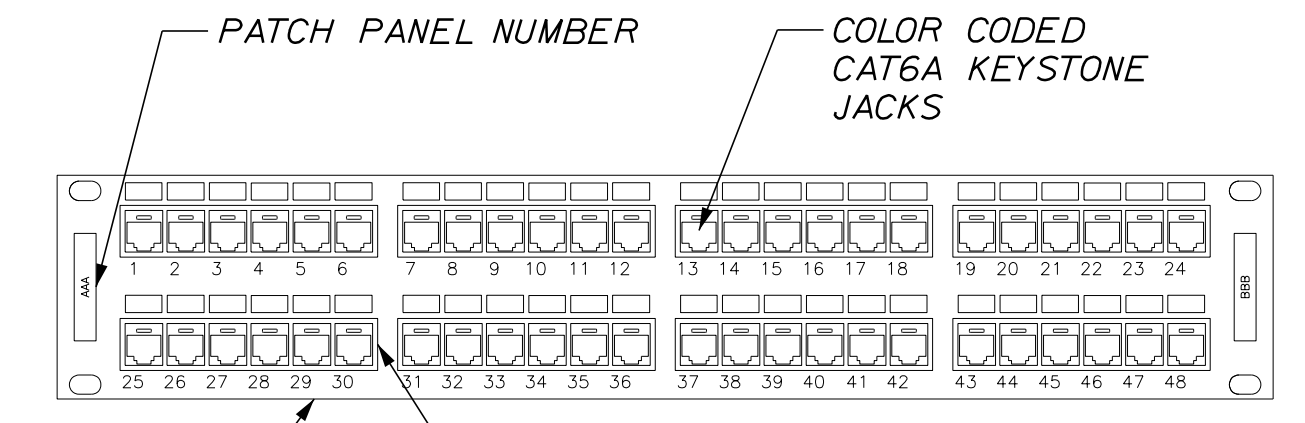

BLANK PANEL WITH KEYSTONE JACK SLOTS

- CAT6A RJ45 CONNECTOR (TYP.)
- BLUE FOR PRIMARY ADMINISTRATIVE PATCH PANEL
 - GREEN FOR SECONDARY ADMINISTRATIVE PATCH PANEL
 - GREY FOR WALL-MOUNT TELEPHONE PATCH PANEL
 - YELLOW FOR WIFI ACCESS POINT PATCH PANEL
 - BLACK FOR SECURITY CAMERA PATCH PANEL
 - BLACK FOR CATV PATCH PANEL

CAT6A PATCH PANEL DETAILS (TYP.)
NOT TO SCALE

4-POST EQUIPMENT RACK AND EQUIPMENT ELEVATION DETAILS (ROOM 001A)
NOT TO SCALE

Filename: ...460_SC-10 TELECOM DETAILS 1.DGN.dgn

Scale: AS NOTED

No.	Revision	By	Date
3	Addendum 3 - Revised Fiber Optic Cable Designation	JD	10/18

Designed by:

JACOBS

CONSULTANT PROJECT MANAGER: T. MORIN

	By	Date	By	Date	
Designed	SSG	7/18	Checked	CJC	7/18
Drawn	EFG	7/18	In Charge of	TWM	7/18

JACOBS ENGINEERING GROUP
120 ST. JAMES AVENUE
BOSTON, MA. 02116
TEL (617) 242-9222
FAX (617) 242-9824



THE GOLD STAR MEMORIAL HIGHWAY

MTA PROJECT MANAGER: R. NORWOOD

YORK TOLL PLAZA

SECURITY AND COMMUNICATIONS
TELECOMMUNICATIONS ELEVATIONS DETAILS

SHEET NUMBER: SC-10

CONTRACT: 2018.20

460 OF 489

Date:10/14/2018

TOLLING - ORT

1. TRANSSCORE SHALL PROVIDE THE FOLLOWING ITEMS TO BE INSTALLED BY THE CONTRACTOR:
 - A. 20 VCARS CAMERA SYSTEMS
 - B. ENCLOSURES AND MOUNTING KITS FOR VCARS
 - C. IVIS LOOP SENSORS AND ASSOCIATED TEMPLATES FOR CUTTING CONCRETE
 - D. EPOXY LOOP SEALANT FOR INSTALLATION OF LOOPS
 - E. 2 ORT HOFFMAN CABINETS (TUNNEL ENCLOSURES)
 - F. MOUNTING CLEATS FOR ORT CABINETS
 - G. COSTAR ENCLOSURES AND PELCO MOUNTING HOOKS FOR DVAS CAMERAS
 - H. 30 OPUS SCANNER, MOUNTING HARDWARE AND ENCLOSURE
2. THE CONTRACTOR SHALL PROVIDE AND INSTALL THE FOLLOWING ITEMS:
 - A. AVI ANTENNA BRACKETS FOR MOUNTING TO SPACE FRAME
 - B. 4 ENCLOSURES FOR AVI READERS
 - C. ALL REQUIRED JUNCTION BOXES, CONDUIT AND ASSOCIATED WIRING
 - D. LEVELING PAD FOR ORT CABINETS
 - E. HOMERUN CABLES FOR IVIS LOOP SENSORS
 - F. KLIK-ITS FOR HOME RUN TERMINATION
3. THE MAINE TURNPIKE SHALL PROVIDE THE FOLLOWING ITEMS TO BE INSTALLED BY THE CONTRACTOR:
 - A. 18 AVI ANTENNAS AND LANE KITS
 - B. 4 AVI READERS (MTA RESPONSIBLE FOR LANE TUNING AND READER SYNCHRONIZATION)
4. TRANSSCORE SHALL PROVIDE, INSTALL AND TERMINATE THE FOLLOWING ITEMS:
 - A. DVAS CAMERAS
 - B. ORT LANE SERVERS AND ASSOCIATED CONTROLLERS AND SWITCHES
5. ALL IVIS SENSOR LOOPS SHALL HAVE AN EPOXY OVERLAY PER SECTION 515 OF SPECIAL PROVISIONS.

TOLLING - CASH LANE

1. TRANSSCORE SHALL PROVIDE THE FOLLOWING ITEMS TO BE INSTALLED BY THE CONTRACTOR:
 - A. PELCO MOUNTING HOOK FOR THE DVAS CAMERA
 - B. IVIS LOOP SENSORS AND ASSOCIATED TEMPLATES FOR CUTTING CONCRETE
 - C. EPOXY LOOP SEALANT FOR INSTALLATION OF LOOPS
 - D. 9 LANE CONTROLLER ENCLOSURES
 - E. MLT VGA AND AUDIO CABLES
 - F. 9 TRAFFIC CONTROL PEDESTALS
 - G. 9 CANOPY OVERRIDE SWITCHES
2. THE CONTRACTOR SHALL PROVIDE AND INSTALL THE FOLLOWING ITEMS:
 - A. ALL REQUIRED JUNCTION BOXES, CONDUIT AND ASSOCIATED COMMUNICATION AND ELECTRICAL WIRING
 - B. RED "X" /GREEN "ARROW" CANOPY LIGHTS ON FRONT OF CANOPY.
 - C. TRAFFIC CONTROL PEDESTAL (INSTALL ONLY)
 - D. LANE CONTROLLER ENCLOSURES AND METAL CLEATS (INSTALL ONLY)
 - E. 2 ENCLOSURES FOR AVI READERS
3. TRANSSCORE SHALL PROVIDE, INSTALL AND TERMINATE (DATA ONLY) THE FOLLOWING ITEMS:
 - A. DVAS CAMERA
 - B. LANE CONTROLLERS
 - C. TRAFFIC CONTROL PEDESTAL (PROVIDE TCP AND TERMINATE DATA ONLY)
 - D. MANUAL LANE TERMINAL AND STAND
 - E. RECEIPT PRINTER
4. THE MAINE TURNPIKE SHALL PROVIDE THE FOLLOWING ITEMS TO BE INSTALLED BY THE CONTRACTOR:
 - A. 9 AVI ANTENNAS AND LANE KITS
 - B. 2 AVI READER (MTA RESPONSIBLE FOR LANE TUNING AND READER SYNCHRONIZATION)
 - C. 9 CANOPY OVERRIDE SWITCHES
5. ALL IVIS SENSOR LOOPS SHALL HAVE AN EPOXY OVERLAY PER SECTION 515 OF SPECIAL PROVISIONS.

TOLLING - GENERAL

1. COORDINATE LOOP LOCATIONS WITH SYSTEMS INTEGRATOR (SI) FOR SOFT CUT JOINTS TO PREVENT SOFT CUTS THROUGH LOOPS.

TOLL SYSTEM INTEGRATOR

3

1. THE CONTRACTOR'S SCHEDULE OF WORK SHALL ACCOUNT FOR THE INSTALLATION OF THE TOLLING EQUIPMENT IN EACH CASH LANE (14 CALENDER DAYS PER LANE). ALL CIVIL WORK IN A CASH LANE SHALL BE COMPLETED BY THE CONTRACTOR PRIOR TO THE INSTALLATION OF THE TOLLING EQUIPMENT IN THE RESPECTIVE LANE. TOLLING EQUIPMENT IS TO BE INSTALLED, TERMINATED, AND TESTED BY THE TOLL SYSTEM INTEGRATOR.
2. THE CONTRACTOR'S SCHEDULE OF WORK SHALL ACCOUNT FOR THE INSTALLATION OF THE TOLLING EQUIPMENT IN EACH ORT ZONE (126 CALENDER DAYS FOR BOTH ORT ZONES, IF DONE CONCURRENTLY, 126 CALENDER DAYS PER ORT ZONE, IF DONE SEPARATELY). ALL CIVIL WORK IN A ORT ZONES SHALL BE COMPLETED BY THE CONTRACTOR PRIOR TO THE INSTALLATION OF THE TOLLING EQUIPMENT IN THE RESPECTIVE ZONES (NB/SB). TOLLING EQUIPMENT IS TO BE INSTALLED, TERMINATED, AND TESTED BY THE TOLL SYSTEM INTEGRATOR.
3. A CASH/ORT LANE SHALL NOT BE OPENED TO TRAFFIC UNTIL ALL TOLLING EQUIPMENT HAS BEEN INSTALLED IN THE RESPECTIVE LANE, HAS BEEN TESTED, AND COMMISSIONING HAS BEEN ACCEPTED BY THE MTA.
4. THE TOLL SYSTEM INTEGRATOR WILL HAVE 14 CALENDER DAYS PER CASH LANE AND 126 CALENDER DAYS PER ORT ZONE (UNLESS DONE CONCURRENTLY). THE CONTRACTOR WILL NEED TO ACCOUNT FOR THE TOLL SYSTEM INTEGRATOR WITHIN THEIR SCHEDULE OF WORK.

ELECTRICAL

1. LOOP GRADIENT SENSOR CONDUIT STUB-UPS WILL BE CONNECTED TO A HOME RUN CONDUIT VIA A 3" SANITARY TEE OR 90 PVC DWV.
2. ALL CONDUIT LOCATED IN THE TOLL LANES SHALL BE INSTALLED IN THE ROADWAY SUBBASE, BELOW THE CONCRETE SLAB. THE ONLY CONDUIT LOCATED WITHIN THE CONCRETE SLAB IS FOR STUB-UPS.
3. "KEY SWITCHES" WILL BE INSTALLED IN EACH CASH LANE FOR THE INLINE CLEAN POWER OF EACH DVAS AND VES. POWER AND DATA CABLES FROM THE CASH LANE CONTROLLERS TO THE DVAS SHALL BE ROUTED UP THROUGH CANOPY SUPPORT COLUMNS. ANY CABLES AND/OR WIRES RUN TO DEVICES ON CANOPIES AND SPACE FRAMES SHALL BE RUN IN CONDUIT.

Filename: 421_Toll General Notes.dgn

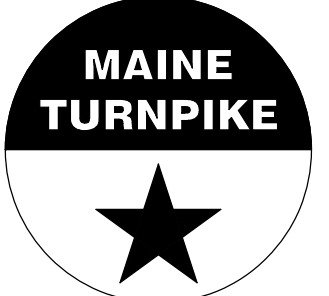
Scale: <p style="text-align: center;">NO SCALE</p>		Designed by: <p style="text-align: center;">HNTB</p>		HNTB CORPORATION 340 County Road, Suite 6-C Westbrook, ME 04092 TEL (207) 774-5155 FAX (207) 228-0909		 <p style="font-size: 1.2em; font-weight: bold;">THE GOLD STAR MEMORIAL HIGHWAY</p>		<p style="font-size: 1.2em;">YORK TOLL PLAZA</p> <p style="font-size: 1.2em;">TOLL GENERAL NOTES</p>																					
<table border="1" style="width: 100%; border-collapse: collapse;"> <thead> <tr> <th style="width: 5%;">No.</th> <th style="width: 75%;">Revision</th> <th style="width: 10%;">By</th> <th style="width: 10%;">Date</th> </tr> </thead> <tbody> <tr> <td style="text-align: center;">1</td> <td>CHANGE WORKING DAYS TO CALENDER DAYS</td> <td style="text-align: center;">RBM</td> <td style="text-align: center;">10/18</td> </tr> </tbody> </table>		No.	Revision	By	Date	1	CHANGE WORKING DAYS TO CALENDER DAYS	RBM	10/18	CONSULTANT PROJECT MANAGER: R. Bruce Munger, P.E.		<table border="1" style="width: 100%; border-collapse: collapse;"> <thead> <tr> <th style="width: 15%;">By</th> <th style="width: 15%;">Date</th> <th style="width: 15%;">By</th> <th style="width: 15%;">Date</th> </tr> </thead> <tbody> <tr> <td style="text-align: center;">RBM</td> <td style="text-align: center;">10/17</td> <td style="text-align: center;">WDA</td> <td style="text-align: center;">10/17</td> </tr> <tr> <td style="text-align: center;">JRD</td> <td style="text-align: center;">10/17</td> <td style="text-align: center;">RAL</td> <td style="text-align: center;">10/17</td> </tr> </tbody> </table>		By	Date	By	Date	RBM	10/17	WDA	10/17	JRD	10/17	RAL	10/17	MTA PROJECT MANAGER: William Yates		SHEET NUMBER: T-01 CONTRACT: 2018.20 4210F 489	
No.	Revision	By	Date																										
1	CHANGE WORKING DAYS TO CALENDER DAYS	RBM	10/18																										
By	Date	By	Date																										
RBM	10/17	WDA	10/17																										
JRD	10/17	RAL	10/17																										

SPECIAL PROVISION

SECTION 634

HIGHWAY LIGHTING

(Highway Lighting)
(Conventional Light Standard with LED Fixture)
(Sign Light)

634.01 Description

The following paragraph is added:

All new luminaires shall also consist of furnishing and installing disconnect fuse kits in the pole base of light standards.

The work shall also consist of furnishing, delivering to the Authority's Sign Shop at Mile 58.3 Northbound, unloading and stacking five (5) 120-277V Conventional Multi-Tap LED spare luminaires. The spare luminaires shall be furnished with a fuse kit, photo cell and ROAM nodes.

All electrical components required for highway lighting not included with the building electrical shall be included under this item.

634.02 General

The following paragraphs are added:

All Contract work shall be overseen by a Maine licensed Master Electrician. The lead person for the field installations shall be either a Maine licensed Master Electrician, or a Maine licensed Journeyman Electrician. Apprentice Electricians, Helper Electricians, Journeyman-In-Training Electricians, and helpers may work under the Master or Journeyman Electrician as permitted under the law.

The Contractor shall comply with National Electrical Code (NFPA 70) as applicable to construction and installation of electrical cable, wire and connectors; provide electrical cable, wire and connectors, which have been listed and labeled by Underwriters Laboratories, and comply with National Electrical Manufacturers Association/Insulated Power Cable Authorities Association Standards publications pertaining to materials, construction and testing wire cable, where applicable.

At a minimum the Contractor shall provide the following field quality control:

- Prior to energizing, check wire for continuity of circuitry and for short circuits with ohmmeter type testing equipment. Correct malfunction when detected.
- Subsequent to wire hook-ups, energize circuitry and demonstrate functioning in accordance with requirements.

634.021 Materials

The following paragraphs are added:

Disconnect fuse kits in pole bases shall be Ideal SLK Disconnect Fuse Kit 30-S2212, or similar approved Ideal SLK Disconnect Fuse Kit, matched to the pole wiring configuration. All hot and neutral wires shall be fused. Ground wires do not need to be fused.

Cobrahead Fixtures: The 120-277V Conventional Multi-Tap LED luminaires shall be one of the following:

- Model # ATB2-80BLEDE85-series, as manufactured from American Electric Lighting
- Road Focus # 241Watt 112LED 4K series, as manufactured by Philips Roadway Lighting

Sign Light Fixtures:

- Holophane SVLED2-SVL-PK3_MVOLT-50K-AMT-GVSVP-AO

No substitute 120-277V Conventional Multi-Tap LED fixtures will be considered. All Luminaires located beyond the shoulder pavement and at the administration building parking lot and access road shall be equipped with house side shields.

Each luminaire shall be provided with a 7 pin NEMA receptacle, a ROAM node, a photocell and a shorting cap. All “spare” photocells and shorting caps shall become property of the Authority.

The Manufacturer shall provide a minimum 5-year warranty on all luminaires, installed and spares, from the Project Completion date.

All luminaires shall be submitted and approved before the luminaires are ordered. Submittals shall include Product Data sheets clearly identifying the product and accessories being proposed, Test Reports and Certifications, and Product Warranties.

All light poles shall be labeled with their respective pole number and circuit number with a minimum 2” letter height visible from approaching traffic. All wiring in the junction boxes shall be labeled with their applicable circuit number.

The Contractor shall supply a scaled drawing of the load center cabinet and/or wall-mounted installation showing the layout and size of each component. Load center cabinets shall be NEMA 4X rated constructed from Grade 316 Stainless Steel. The ROAM node shall be installed to each luminaire.

The Contractor shall supply and install the ROAM Concierge lighting control system with a (3) three year service package with Acuity Brands Lighting. The ROAM system shall consist of a ROAM node at each light fixture, one gateway, Ethernet, wiring for Ethernet drops, Google Maps, System Start Up and Training. The Contractor shall supply a scaled drawing of

the lighting panel as located in the administration building for approval by MTA before installation.

634.04 Cable Installation

The following paragraphs are added:

All conductors from load center to light poles shall be meggar tested and meggar sheets shall be submitted to MTA for approval.

634.092 Method of Measurement

Delete Method of Measurement and replace with the following:

Highway Lighting System will be measured by the lump sum.

Conventional Light Standard with LED fixture will be measured by the single unit, complete in place and accepted.

Sign Lights will be measured by the single, unit, complete in place and accepted, including all brackets, wiring, controls, labor and materials.

634.093 Basis of Payment

Delete Basis of Payment and replace with the following:

Highway Lighting shall be shall be full compensation for furnishing and installing the highway lighting system from the pole junction boxes to the load center, including: wiring in underground conduit from pole junction boxes to the load center (irrespective of the number of wires or total linear feet of wire required to complete the work), load center components, materials, labor, equipment, tools, miscellaneous hardware and incidentals necessary to complete the work.

Furnishing and installing Load Center shall include panelboards, contactors, breakers, utility service connections and all components required for a fully functional system and all incidentals necessary to complete the work will not be paid separately, but shall be considered incidental to the Highway Lighting item.

ROAM lighting control system shall include all nodes, gateways, Google Maps, 3 year monitoring service, system start up and training, wiring, wiring for system gateways, Ethernet and Ethernet drops, mounting and all incidentals to compete the work shall not be paid separately, but shall be incidental to the Highway Lighting item.

Furnishing, delivering to the Authority's Sign Shop at Mile 58.3 Northbound, unloading and stacking five (5) 120-277V Conventional Multi-Tap LED spare luminaire including fuse kit, photo cell and ROAM nodes shall not be paid separately, but shall be incidental to the Highway Lighting item.

Payment for furnishing and installing and erecting Conventional Light Standard with LED Fixture will be made for the accepted quantity at the contract unit price of each, which shall include: pole wiring, wiring in underground conduit to the pole junction box, and all other wiring, transformer enclosures, luminaires, LED fixture, disconnect fuse kit, photo cell, light standard, breakaway transformer base, break away devices, bracket arm, all identification tags, and all materials, labor, equipment, tools, miscellaneous hardware and incidentals necessary to complete the work.

Payment for Sign Light shall include light fixture, bracket, mounting, conduit, junction boxes, photocells, and all wiring to the electrical panel.

No separate payment will be made for bonding, grounding and ground rods; these costs shall be included in the contract price for conduit, light standards, service panels, or other items requiring bonding and grounding

Payment will be made under:

<u>Pay Item</u>	<u>Pay Unit</u>
634.16 Highway Lighting	Lump Sum
634.231 Conventional Light Standard with LED Fixture	Each
634.232 Sign Light	Each

SPECIAL PROVISIONSECTION 800MISCELLANEOUS INCIDENTALS

(New Toll Booth Installation)

800.1 Description

Division 800 specifies materials, procedures, and requirements for the construction of the Toll Facilities, comprised of: installation of nine toll booths and all associated utilities and services within the limits shown on the Drawings. The work shall be phased as noted on the Plans and outlined in the Specification.

Toll Booth installation includes, but is not limited to the following:

1. Pick up, transport and installation of nine (9) toll booths complete with aluminum sub-frames, floors, doors, windows, counters, etc. Caulking and sealing of booths to concrete is part of the installation. Weather-stripping to be furnished by others.
2. Cutting, patching, and sealing as required to complete the work per Plans and Specifications.

All material associated with Toll Booths installation is included in this item and is shown on the Plan drawings and described in this Special Provision. Electrical and communication items associated with the toll system will be paid for under the specific item. Furnishing and installing plumbing, heating, and ventilating items in the toll booths will be paid for under Item 800.22 HVAC Tunnel and Booths.

The toll booth roofs are not capable of supporting construction loads (materials, equipment, construction workers, etc.). The Contractor is responsible for providing any necessary staging or temporary supports for accessing the toll booth roofs.

800.2 Method of Measurement

The Toll Booth installation will be measured for payment by the lump sum, complete, in-place for the Toll Booth installations.

The MTA will supply the toll booths for installation. The Contractor shall transport toll booths from Authority's York Maintenance Facility Mile 7.0. The installation will include all electrical, mechanical and toll systems required as described in the Plans and within this specification, and all labor, material and equipment needed to provide a fully functioning toll booth will be incidental to this item.

The installation toll booths will also include the needed material for securing the toll booth within the booth pit and making it weather tight, which will include but not be limited to (2) 12' – galvanized steel 3 1/2" X 5" angles and all needed hardware for mounting, installation

of aluminum trim angle as detailed on sheet A-05, and installation of sealing material around the HVAC roof penetrations in the tool booth roof.

800.3 Basis of Payment

Toll Booths will be paid for at the lump sum price bid which shall be full compensation for the cost of furnishing all materials, equipment, supplies, tools, incidentals, and labor and supervision necessary to satisfactorily complete all work prescribed in Division 800 of these Special Provisions.

Payment will be made under:

<u>Pay Item</u>	<u>Pay Unit</u>
800.51 New Toll Booth Installation	Lump Sum

SECTION 16800

TELECOMMUNICATIONS CABLING

PART 1 - GENERAL

1.1 SUMMARY

A. Section Includes:

1. Unshielded Twisted Pair (UTP) Cable.
2. Coaxial Cable.
3. Fiber Optic Cable.
4. Cable Hardware.
5. Telecommunications Outlet/Connectors.

B. Related Requirements:

1. Section 16825 "Telecommunications Equipment"

1.2 ACTION SUBMITTALS

- A. As-Built Drawings. Submit prior to final acceptance of the work, drawings showing complete layout of systems installed including physical location of ground rods to which connections were made.
- B. Field Quality Control Test Report. Submit reports complying with requirements of Part 3 "Field Quality Control" Article.

1.3 DEFINITIONS

- A. BICSI: Building Industry Consulting Service International.
- B. Cross-Connect: A facility enabling the termination of cable elements and their interconnection or cross-connection.
- C. EMI: Electromagnetic interference.
- D. IDC: Insulation displacement connector.
- E. LAN: Local area network.
- F. Outlet/Connectors: A connecting device in the work area on which horizontal cable or outlet cable terminates.
- G. RCDD: Registered Communications Distribution Designer.
- H. UTP: Unshielded twisted pair.

PART 2 - PRODUCTS

2.1 HORIZONTAL CABLING DESCRIPTION

- A. Horizontal cable and its connecting hardware provide the means of transporting signals between the telecommunications outlet/connector and the horizontal cross-connect located in the MTA Communications Room (Room 001A). This cabling and its connecting hardware are called a "permanent link," a term that is used in the testing protocols.
 - 1. TIA-568-C.1 requires that a minimum of two telecommunications outlet/connectors be installed for each work area.
 - 2. Horizontal cabling shall contain no more than one transition point or consolidation point between the horizontal cross-connect and the telecommunications outlet/connector.
 - 3. Bridged taps and splices shall not be installed in the horizontal cabling.
- B. A work area includes the components that extend from the telecommunications outlet/connectors to the local equipment.
- C. The maximum allowable horizontal cable length for Category 6A cable is 295 feet (90 m). This maximum allowable length does not include an allowance for the length of 16 feet (4.9 m) to the workstation equipment or in the horizontal cross-connect.

2.2 PERFORMANCE REQUIREMENTS

- A. General Performance: Horizontal cabling system shall comply with transmission standards in TIA-568-C.1 when tested according to test procedures of this standard.
- B. Surface-Burning Characteristics: Comply with ASTM E 84; testing by a qualified testing agency. Identify products with appropriate markings of applicable testing agency.
 - 1. Flame-Spread Index: 25 or less.
 - 2. Smoke-Developed Index: 50 or less.
- C. Electrical Components, Devices, and Accessories: Listed and labeled as defined in NFPA 70, by a qualified testing agency, and marked for intended location and application.
- D. Grounding: Comply with J-STD-607-A.

2.3 UTP CABLE

- A. Manufacturers: Subject to compliance with requirements, available manufacturers offering products that may be incorporated into the Work include, but are not limited to, the following:

1. ADC.
 2. Belden Inc.
 3. General Cable
 4. Mohawk; a division of Belden Networking, Inc.
 5. Superior Essex Inc.
- B. Description: 100-ohm, Category 6A, #23 AWG solid copper, unshielded twisted pair (UTP) cabling as indicated on drawings, formed into 4-pair binder groups, with a core and pair separator, covered with a thermoplastic jacket.
- C. Listed and labeled by an NRTL acceptable to authorities having jurisdiction as complying with UL 444 and NFPA 70 for the following types:
1. Communications, Plenum Rated: Type CMP, complying with NFPA 262.

2.4 UTP CABLE HARDWARE

- A. Manufacturers: Subject to compliance with requirements, available manufacturers offering products that may be incorporated into the Work include, but are not limited to, the following:
1. ADC.
 2. American Technology Systems Industries, Inc.
 3. Belden Inc.
 4. Hubbell Premise Wiring.
 5. Leviton Commercial Networks Division.
 6. Legrand, Ortronics
 7. Molex Premise Networks; a division of Molex, Inc.
 8. Panduit Corp.
- B. General Requirements for Cable Connecting Hardware: Comply with TIA-568-C.2, IDC type, with modules designed for punch-down caps or tools. Cables shall be terminated with connecting hardware of same category or higher.
- C. Connecting Blocks: 110-style IDC for Category 6A. Provide blocks for the number of cables terminated on the block, plus 25 percent spare. Integral with connector bodies, including plugs and jacks where indicated.
1. Number of Terminals per Field: One for each conductor in assigned cables.
- D. Patch Panel: Modular, blank, keystone-type patch panels housing multiple-numbered spaces for jack units for installation of snap-in keystone jacks.
1. Number of Jacks per Field: One for each four-pair UTP cable indicated, plus spares and blank positions adequate to suit specified expansion criteria.
- E. Jacks and Jack Assemblies: Modular, keystone snap-in, color-coded, Category 6A, eight-position receptacle units with integral IDC-type terminals.

1. Jacks shall be terminated according to T568B standard.

F. Patch Cords: Factory-made, Category 6A patch cables, in the following quantities and lengths:

1. Fifty (50) – 2-meter lengths – Blue.
2. Fifty (50) – 2-meter lengths – Green.

2.5 COAXIAL CABLE

A. Manufacturers: Subject to compliance with requirements, acceptable manufacturers offering products that may be incorporated into the Work include, but are not limited to, the following:

1. Alpha Wire Company.
2. Belden CDT Inc.; Electronics Division.
3. Coleman Cable, Inc.
4. CommScope, Inc.
5. Draka USA.

B. Cable Characteristics: Broadband type, recommended by cable manufacturer specifically for broadband data transmission applications. Coaxial cable and accessories shall have 75-ohm nominal impedance with a return loss of 20 dB maximum from 7 to 806 MHz.

C. RG-6/U: NFPA 70, Type CATV or CM.

1. No. 16 AWG, solid, copper-covered steel conductor; gas-injected, foam-PE insulation.
2. Double shielded with 100 percent aluminum-foil shield and 60 percent aluminum braid.
3. Jacketed with black PVC or PE.
4. Suitable for indoor installations.

2.6 COAXIAL CABLE HARDWARE

A. Manufacturers: Subject to compliance with requirements, acceptable manufacturers offering products that may be incorporated into the Work include, but are not limited to, the following:

1. Aim Electronics; a brand of Emerson Electric Co.
2. Leviton Voice & Data Division.
3. Simon Co. (The).

B. Coaxial-Cable Connectors: Type F, 75 ohms - compression.

2.7 MULTIMODE OPTICAL FIBER CABLE

- A. Reference special provisions Section 655 (Communications) for requirements of multimode fiber optic cable.
- B. Manufacturers: Subject to compliance with requirements, available manufacturers offering products that may be incorporated into the Work include, but are not limited to, the following:
 - 1. Corning Cable Systems.
- C. Description: OM1 multimode, 62.5/125-micrometer, nonconductive, indoor/outdoor, tight buffer, optical fiber cable. Provide total number of cables as indicated on plans.
 - 1. Comply with ICEA S-83-596 for mechanical properties.
 - 2. Shall have a minimum of 6 strands.
 - 3. Comply with TIA-568-C.3 for performance specifications.
 - 4. Listed and labeled by an NRTL acceptable to authorities having jurisdiction as complying with UL 444, UL 1651, and NFPA 70 for the following types:
 - a. Plenum Rated, Nonconductive: Type OFNP, dry water blocking, complying with NFPA 262.
 - 5. Maximum Attenuation: 3 dB/km at 850 nm and 1dB/km at 1300 nm.
- D. Jacket:
 - 1. Jacket Color: Orange.
 - 2. Cable cordage jacket, fiber, unit, and group color shall be according to TIA-598-B.
 - 3. Imprinted with fiber count, fiber type, and aggregate length at regular intervals not to exceed 40 inches.

2.8 OPTICAL FIBER CABLE HARDWARE

- A. Manufacturers: Subject to compliance with requirements, available manufacturers offering products that may be incorporated into the Work include, but are not limited to, the following:
 - 1. Corning Cable Systems.
 - 2. Hubbell Premise Wiring.
 - 3. Molex Premise Networks; a division of Molex, Inc.
 - 4. Ortronics/Legrand
 - 5. Panduit.
- B. Cross-Connects and Patch Panels: Rack mounted modular panels housing multiple-numbered, duplex LC cable connectors. Bi-directions sliding draws for both front and rear access to fibers and fiber optic splice trays.
 - 1. Number of Connectors per Field: One for each fiber of cable or cables assigned to field, plus 25 percent spare and blank positions.

- C. Patch Cords: Factory-made, OM1 multimode single fiber patch cables, with ST connectors at patch panel and LC connectors as required for connection to SFPs, in the following quantities and lengths:
1. Twenty-five (25) – 3-meter lengths - Orange.
- D. Pigtails: Factory-made, OM1 multimode single fiber 900micron pigtails.
1. Factory-made.
 2. Furnish, and fusion splice, one for each strand of each multimode fiber optic cable for termination onto fiber patch panels.
 3. Comply with TIA-568-C.3 performance requirements.
 4. ST to pigtail.
 5. ST connector housing and boot colors follow TIA-568-C.3 suggested color identification scheme.
 6. Insertion loss per connection: 0.1dB typical, 0.25dB maximum.
- E. Cable Connecting Hardware:
1. Comply with Optical Fiber Connector Intermateability Standards (FOCIS) specifications of TIA-604-2, TIA-604-3-A, and TIA-604-12. Comply with TIA-568-C.3.
 2. Quick-connect, simplex and duplex, Type LC connectors. Insertion loss not more than 0.75 dB.
- F. Cable Connecting Hardware:
1. Comply with Optical Fiber Connector Intermateability Standards (FOCIS) specifications of TIA-604-2, TIA-604-3-A, and TIA-604-12. Comply with TIA-568-C.3.
 2. Quick-connect, simplex and duplex, Type LC connectors. Insertion loss not more than 0.75 dB.

2.9 TELECOMMUNICATIONS OUTLET/CONNECTORS

- A. Jacks: 100-ohm, balanced, twisted-pair connector; four-pair, eight-position modular. Comply with TIA-568-C.1 Category 6A.
1. Jacks shall be colored to match connecting CAT6A cable
- B. Workstation Outlets: two-port connector assemblies mounted in single faceplate or as shown on drawings.
1. Plastic Faceplate: High-impact plastic.
 2. Stainless Steel recessed wall plate with mounting studs.

2.10 GROUNDING

- A. Comply with requirements in "Grounding and Bonding for Electrical Systems" for grounding conductors and connectors.
- B. Comply with J-STD-607-A.

2.11 IDENTIFICATION PRODUCTS

- A. Comply with TIA-606-A and UL 969 for labeling materials, including label stocks, laminating adhesives, and inks used by label printers.
- B. Label all new cables with identification on both cable ends including: "Cable type", "Cable to", and "Cable from". Comply with labeling standard recommendations of TIA-606-A.

PART 3 - EXECUTION

3.1 PREPARATION

- A. Perform testing as specified in Part 3 "Field Quality Control" Article.

3.2 WIRING METHODS

- A. Install cables in pathways.
- B. Wiring within Enclosures:
 - 1. Bundle, lace, and train conductors to terminal points with excess and without exceeding manufacturer's limitations on bending radii.
 - a. Provide a minimum of twenty (20) feet of excess for all fiber optic cabling and spool in patch panels and/or handholes.
 - 2. Install lacing bars and distribution spools.
 - 3. Install conductors parallel with or at right angles to sides and back of enclosure.

3.3 INSTALLATION OF CABLES

- A. Comply with NECA 1.
- B. General Requirements for Cabling:
 - 1. Comply with TIA-568-C.1.
 - 2. Comply with BICSI ITSIM, Ch. 6, "Cable Termination Practices."
 - 3. Install 110-style IDC termination Category 6A hardware unless otherwise indicated.
 - 4. Terminate conductors; no cable shall contain unterminated elements. Make terminations only at indicated outlets, terminals, cross-connects, and patch panels.

5. Cables may not be spliced. Secure and support cables at intervals not exceeding 30 inches (760 mm) and not more than 6 inches (150 mm) from cabinets, boxes, fittings, outlets, racks, frames, and terminals.
6. Install lacing bars to restrain cables, to prevent straining connections, and to prevent bending cables to smaller radii than minimums recommended by manufacturer.
7. Bundle, lace, and train conductors to terminal points without exceeding manufacturer's limitations on bending radii, but not less than radii specified in BICSI ITSIM, "Cabling Termination Practices". Install lacing bars and distribution spools.
8. Do not install bruised, kinked, scored, deformed, or abraded cable. Do not splice cable between termination, tap, or junction points. Remove and discard cable if damaged during installation and replace it with new cable.
9. Pulling Cable: Comply with BICSI ITSIM, Chapter 4, "Pulling Cable." Monitor cable pull tensions.

C. UTP Cable Installation:

1. Comply with TIA-568-C.2.
2. Do not untwist UTP cables more than 1/2 inch (12 mm) from the point of termination to maintain cable geometry.

D. Optical Fiber Cable Installation:

1. Comply with TIA-568-C.3.
2. Cable shall only be terminated on connecting hardware that is rack or cabinet mounted. Unicam connectors are not acceptable.
3. Slack:
 - a. At each manhole a minimum of 50' slack cable coil is required.
 - b. At the communication room terminations, a minimum of 50' slack cable coil is required.

E. Group connecting hardware for cables into separate logical fields.

F. Separation from EMI Sources:

1. Comply with BICSI TDMM and TIA-569-B for separating unshielded copper voice and data communication cable from potential EMI sources, including electrical power lines and equipment.
2. Separation between open communications cables or cables in nonmetallic raceways and unshielded power conductors and electrical equipment shall be as follows:
 - a. Electrical Equipment Rating Less Than 2 kVA: A minimum of 5 inches (127 mm).
 - b. Electrical Equipment Rating between 2 and 5 kVA: A minimum of 12 inches (300 mm).
 - c. Electrical Equipment Rating More Than 5 kVA: A minimum of 24 inches (610 mm).

3. Separation between communications cables in grounded metallic raceways and unshielded power lines or electrical equipment shall be as follows:
 - a. Electrical Equipment Rating Less Than 2 kVA: A minimum of 2-1/2 inches (64 mm).
 - b. Electrical Equipment Rating between 2 and 5 kVA: A minimum of 6 inches (150 mm).
 - c. Electrical Equipment Rating More Than 5 kVA: A minimum of 12 inches (300 mm).
4. Separation between communications cables in grounded metallic raceways and power lines and electrical equipment located in grounded metallic conduits or enclosures shall be as follows:
 - a. Electrical Equipment Rating Less Than 2 kVA: No requirement.
 - b. Electrical Equipment Rating between 2 and 5 kVA: A minimum of 3 inches (76 mm).
 - c. Electrical Equipment Rating More Than 5 kVA: A minimum of 6 inches (150 mm).
5. Separation between Communications Cables and Electrical Motors and Transformers, 5 kVA or HP and Larger: A minimum of 48 inches (1200 mm).
6. Separation between Communications Cables and Fluorescent Fixtures: A minimum of 5 inches (127 mm).

3.4 FIRESTOPPING

- A. Comply with TIA-569-B, Annex A, "Firestopping."
- B. Comply with BICSI TDMM, "Firestopping Systems" Article.

3.5 GROUNDING

- A. Install grounding according to BICSI TDMM, "Grounding, Bonding, and Electrical Protection" Chapter.
- B. Comply with J-STD-607-A.

3.6 IDENTIFICATION

- A. Identify system components, wiring, and cabling complying with TIA-606-A.
 1. Color-code cross-connect fields. Apply colors to voice and data service backboards, connections, covers, and labels.
- B. Cable Schedule: Post in prominent location in each equipment room and wiring closet. List incoming and outgoing cables and their designations, origins, and destinations.

Protect with rigid frame and clear plastic cover. Furnish an electronic copy of final comprehensive schedules for Project.

- C. Cabling Administration Drawings: Show building floor plans with cabling administration-point labeling. Identify labeling convention and show labels for telecommunications closets, backbone pathways and cables, entrance pathways and cables, terminal hardware and positions, horizontal cables, work areas and workstation terminal positions, grounding buses and pathways, and equipment grounding conductors. Follow convention of TIA-606-A. Furnish electronic record of all drawings, in software and format approved by the MTA.
- D. Cable and Wire Identification:
1. Label each cable within 4 inches (100 mm) of each termination and tap, where it is accessible in a cabinet or junction or outlet box, and elsewhere as indicated.
 2. Exposed Cables and Cables in Cable Trays and Wire Troughs: Label each cable at intervals not exceeding 15 feet (4.5 m).
 3. Label each terminal strip and screw terminal in each cabinet, rack, or panel.
 - a. Individually number wiring conductors connected to terminal strips, and identify each cable or wiring group being extended from a panel or cabinet to a building-mounted device shall be identified with name and number of particular device as shown.
 - b. Label each unit and field within distribution racks and frames.
 4. Identification within Connector Fields in Equipment Rooms and Wiring Closets: Label each connector and each discrete unit of cable-terminating and connecting hardware.
- E. Labels shall be preprinted or computer-printed type with printing area and font color that contrasts with cable jacket color but still complies with requirements in TIA-606-A.
1. Cables use flexible vinyl or polyester that flex as cables are bent.

3.7 FIELD QUALITY CONTROL

- A. Perform the following tests and inspections:
1. Visually inspect all cable jacket materials for NRTL certification markings. Inspect cabling terminations in communications equipment rooms for compliance with color-coding for pin assignments, and inspect cabling connections for compliance with TIA-568-C.1.
 2. Visually confirm Category 6A, marking of outlets, cover plates, outlet/connectors, and patch panels.
 3. Visually inspect cable placement, cable termination, grounding and bonding, equipment and patch cords, and labeling of all components.
 4. Test UTP copper cabling for DC loop resistance, shorts, opens, intermittent faults, and polarity between conductors. Test operation of shorting bars in connection blocks. Test cables after termination but not cross-connection.

- a. Test instruments shall meet or exceed applicable requirements in TIA-568-C.2. Perform tests with a tester that complies with performance requirements in "Test Instruments (Normative)" Annex, complying with measurement accuracy specified in "Measurement Accuracy (Informative)" Annex. Use only test cords and adapters that are qualified by test equipment manufacturer for channel or link test configuration.
5. UTP Performance Tests:
 - a. Test for each outlet. Perform the following tests according to TIA-568-C.1 and TIA-568-C.2:
 - 1) Wire map.
 - 2) Length (physical vs. electrical, and length requirements).
 - 3) Insertion loss.
 - 4) Near-end crosstalk (NEXT) loss.
 - 5) Power sum near-end crosstalk (PSNEXT) loss.
 - 6) Equal-level far-end crosstalk (ELFEXT).
 - 7) Power sum equal-level far-end crosstalk (PSELFEXT).
 - 8) Return loss.
 - 9) Propagation delay.
 - 10) Delay skew.
6. Final Verification Tests: Perform verification tests for UTP systems after the complete communications cabling and workstation outlet/connectors are installed.
7. Optical Fiber Cable Tests:
 - a. All fiber delivered on reel shall be OTDR tested prior to installation, assuring the test match the manufacturer supplied results.
 - b. All fiber terminations and testing shall be completed by a technician certified to perform this work. Resumes or personnel will be required for approval.
 - c. Test instruments shall meet or exceed applicable requirements in TIA-568-C.1. Use only test cords and adapters that are qualified by test equipment manufacturer for channel or link test configuration.
 - d. Link End-to-End Attenuation Tests:
 - 1) Multimode measurements: Test at 850nm and 1300nm in both directions (bidirectionally) according to TIA-526-14-A, Method B, One Reference Jumper.
 - 2) Attenuation test results for optical links shall be less than .5dB/km for 1310 and .4dB/km for 1550. Attenuation test results shall be less than that calculated according to equation in TIA-568-C.1.
 - 3) Shall be conducted with an approved OTDR and Power Meter (OLTS).

- a) There shall be no cable end splices between the 2 ends of the cable as shown on the Contract Documents. Splice loss for pigtails shall not exceed .2dB when tested bidirectionally via the OTDR.
 - 4) All shall be conducted and analyzed bidirectionally.
 - 5) All OTDR and OLTS reports shall be submitted to the Engineer for review and approval before acceptance and use.
- B. Data for each measurement shall be documented. Data for submittals shall be printed in a summary report that is formatted similar to Table 10.1 in BICSI TDMM, or transferred from the instrument to the computer, saved as text files, and printed and submitted.
- C. End-to-end cabling will be considered defective if it does not pass tests and inspections.
- D. Prepare and submit test and inspection reports for MTA acceptance.

END OF SECTION

SECTION 16825

TELECOMMUNICATIONS EQUIPMENT

PART 1 - GENERAL

1.1 SUMMARY

A. Section Includes:

1. Equipment Frames.
2. Ethernet Switches and Transceivers.
3. Uninterruptable Power Supplies (UPS).
4. LED Video Display.
5. Small Form Factor (SFF) Computer.
6. Grounding
7. Identification Products
8. ITS CCTV Pole
9. ITS Equipment cabinet
10. ITS CCTV Camera

B. Related Requirements:

1. Section 16800 "Telecommunications Cabling"

1.2 SUBMITTALS

- A. As-Built Drawings. Submit prior to final acceptance of the work, drawings showing complete layout of equipment installed.
- B. Field Quality Control Test Report. Submit reports complying with requirements of Part 3 "Field Quality Control" Article.

1.3 DEFINITIONS

- A. BICSI: Building Industry Consulting Service International.
- B. Cross-Connect: A facility enabling the termination of cable elements and their interconnection or cross-connection.
- C. EMI: Electromagnetic interference.
- D. IDC: Insulation displacement connector.
- E. LAN: Local Area Network.
- F. Outlet/Connectors: A connecting device in the work area on which horizontal cable or outlet cable terminates.

- G. RCDD: Registered Communications Distribution Designer.
- H. UTP: Unshielded twisted pair.

PART 2 - PRODUCTS

2.1 UNINTERRUPTABLE POWER SUPPLY (UPS)

- A. UPS will be supplied by the Authority and installed by the Contractor for the MTA Communications Room equipment.

2.2 ETHERNET SWITCHES

A. Administrative Ethernet Switch

1. Administrative Ethernet switch shall be a commercial-grade, forty-eight (48) port, 10/100/1000 compliant Ethernet switch with at least four (4) SPF slots supporting industry standard mini-GBIC optical or copper transceivers.
2. Administrative Ethernet switch shall be compatible with EIA 310-D standard, 19-inch (480-mm) panel mounting and be mounted in the Floor-Mounted Equipment Rack in the MTA Communications Room (Room 001A) as indicated on plans.

B. Security Ethernet Switch

1. Security Ethernet switch shall be a commercial-grade, twenty-four (24) port, 10/100/1000 compliant Ethernet switch with at least two (2) SPF slots supporting industry standard mini-GBIC optical or copper transceivers.
2. Security Ethernet switch shall support the 802.3af power over Ethernet (POE) standard.
3. Security Ethernet switch shall be compatible with EIA 310-D standard, 19-inch (480-mm) panel mounting and be mounted in the Floor-Mounted Equipment Rack in the MTA Communications Room (Room 001A) as indicated on plans.

C. ITS Ethernet Switch

1. ITS Ethernet switch shall be a commercial-grade, eight (8) port, 10/100/1000 compliant Ethernet switch with at least four (2) SPF slots supporting industry standard mini-GBIC optical or copper transceivers.
2. Administrative Ethernet switch shall be compatible with EIA 310-D standard, 19-inch (480-mm) panel mounting and be mounted in the Floor-Mounted Equipment Rack in the MTA Communications Room (Room 001A) as indicated on plans.

D. ITS Ethernet to Fiber Transceivers

1. ITS Ethernet to Fiber Transceivers shall be a commercial-grade, 10/100 compliant transceiver (IEEE 802.3 for 10BaseT, IEEE 802.3u for 100BaseT(X) and 100BaseFX, IEEE 802.3x for Flow Control), with one duplex fixed optical ports in SC or ST, and a

minimum of one copper ethernet port 10/100BaseT(X) rated for outdoor environments of -40°C to 40°C, DIN Rail mountable, sourced by 120vac power.

2. ITS Ethernet to Fiber Transceivers shall be mounted in ITS Equipment cabinet located at each CCTV, as indicated on plans.

2.3 LED VIDEO DISPLAY

- A. Provide one (1) Professional, commercial-grade LED Flat Panel Video Display and ceiling-mount for installation in the Supervisor Room (Room 102). LED Flat Panel shall have the following minimum specifications.

1. 50" Diagonal viewing area.
2. Professional/commercial-grade designed for 24/7 operation.
3. Full HD 1080p resolution (1920 x 1080).
4. Dynamic Contrast Ratio: 80,000:1.
5. Mounting Size: VESA 400 x 400 (mm).
6. Thin bezel, black color exterior case.
7. Exceeds ENERGY STAR standards.
8. HDMI and PC inputs.

2.4 SMALL FORM FACTOR (SFF) COMPUTER

A. Product Description

1. The SFF computer shall receive streaming video content from the Network ITS cameras for display on the LED Flat Panel Video Display. The SFF computer shall work independently and without attendance of any personnel. The functions available on the SFF computer shall be accessible by authorized users.
2. The SFF computer shall be of an ultra-compact format and mounted behind the LED Flat Panel Video Display.
3. Include one (1) HDMI cable, 3ft., to connect to the LED Flat Panel Video Display.

B. SFF minimum Computer Requirements

1. The SFF computer shall conform to the following minimum specifications:
 - a. CPU: Intel® Core™ i7-6700T (2.8 GHz, up to 3.6 GHz w/Turbo Boost, 8 MB cache, 4 cores).
 - b. RAM: 16GB DDR4.
 - c. Network: Wired Ethernet 10/100/1000 Mbps, auto.
 - d. Graphics Adapter: Intel® HD Graphics 530 with HDMI.
 - e. Hard Disk Type: 128 GB SATA, 2.5" SSD.
 - f. Input Device: Wireless Keyboard and Mouse.
 - g. Operating System: Windows 10 Pro 64bit.

2.5 GROUNDING

- A. Comply with requirements in "Grounding and Bonding for Electrical Systems" for grounding conductors and connectors.
- B. Comply with J-STD-607-A.

2.6 IDENTIFICATION PRODUCTS

- A. Comply with TIA-606-A and UL 969 for labeling materials, including label stocks, laminating adhesives, and inks used by label printers.
- B. Label all new cables with identification on both cable ends including: "Cable type", "Cable to", and "Cable from"

2.7 ITS CCTV POLE

- A. Manufacturers: Subject to compliance with requirements, available manufacturers offering products that may be incorporated into the Work include, but are not limited to, the following:
 - 1. Valmont
 - 2. Union Metal
 - 3. Other, as approved by the Engineer
- B. The Contractor shall furnish and install a ITS CCTV camera poles with anchor bolts and foundation; mounting brackets for CCTV; weatherheads for future ITS equipment; testing; all cable and wiring; ground rods, equipment grounding and bonding; and all other equipment, materials and incidental items necessary to provide a complete, fully operational camera pole.
- C. Camera Poles shall be a galvanized steel pole.and include mounting hardware for camera/dome assembly.
- D. Two 2" Weatherheads – weatherheads shall be factory installed at approximately 20 feet from the base and 5 feet from the top of the pole and reinforced. Field drilling will not be allowed.
- E. 3" Condulet for wire access between the pole and cabinet.
- F. The contractor shall supply and install a lightning dissipater mounted to the camera pole, approximately 72" in length, be candelabra type and shall provide a minimum of three spot dissipaters, and shall use all Stainless steel hardware.
- G. The height of the pole shall be as specified in the contract documents.
- H. The pole shall be able to sustain 110 MPH winds. The maximum horizontal deflection at the top of the pole completely assembled with a camera and other fixtures shall not exceed 1.25" in any direction under a steady, non-gust wind of 50 MPH.

- I. The pole shall be constructed of galvanized steel and high strength low-alloy steel conforming to A595, Grade A, unless otherwise noted.
- J. All weatherheads, hand holes, conduit access points shall be factory installed and no field drilling shall be allowed. The dome shall be mounted on the side closest to the road to provide a maximum unobstructed view of the mainline and/or toll zone.

2.8 ITS EQUIPMENT CABINET

- A. Manufacturers: Subject to compliance with requirements, available manufacturers offering products that may be incorporated into the Work include, but are not limited to, the following:
 - 1. Southern Manufacturing
 - 2. Mass Electrical Apparatuses
 - 3. Hoffman
 - 4. Other, as approved by the Engineer
- B. The Contractor shall furnish and install a Pole Mounted ITS Equipment Cabinet, at each CCTV Pole as indicated on the contract Documents.
- C. The ITS field cabinet shall meet NEMA 3R requirements.
- D. The cabinet shall be equipped with standard 19" EIA rack rails with both upper and lower mounting straps and shall be UL listed. 19" Rack mounted shelves and/or DIN rails shall be provided for equipment that cannot be rack mounted.
- E. The minimum cabinet dimensions shall be 24"W x 46"H x 20"D and shall be sized to house the proposed equipment with an additional 50% spare rack space for future expansion.
- F. The cabinet for the CCTV shall be pole mounted.
- G. The cabinet shall have two full size locking doors located on opposite sides of the cabinet, hinged on the right or left depending on field conditions.
- H. A 3'0" x 2'6" x 4" cement concrete work pad shall be installed in front of each cabinet door. The pad shall be placed on a minimum of 4-inches of compacted granular material. The pad shall be set with at least 1 percent grade such that any water on the pad shall flow away from the cabinet.
- I. The doorframe openings shall be flanged in all four sides. These flanges should increase the strength and prevent dust and liquids from entering the enclosure when the doors are opened. The door seals shall have a rubber gasket to provide a weather tight seal.
- J. The cabinet shall have a sunshield that covers the top.
- K. The doors shall be equipped with three-point latching mechanisms with nylon rollers at the top and bottom.

- L. The cabinet enclosure shall be 0.125" thick and made of aluminum alloy Type 5052.
- M. The door handles shall be 0.75" stainless steel round bars and have provision for a padlock.
- N. All exterior seams shall be sealed tight with a silicone sealant.
- O. The cabinet shall be supplied with captive door restraint bars.
- P. The bars shall allow the doors to be kept open at a minimum of two different angles one at 90 degrees and the other in a fully open position).
- Q. Ventilation in the cabinet shall consist of a thermostatically controlled 100 CFM fan with louvered air intake in the doors, with pleated filters.
- R. The cabinet shall be mounted to the pole at a height that allows the technician access while standing on the foundation (ground level) or maintenance pad. The bottom of the cabinet shall be at least 2 feet above the foundation, and the top shall be no more than 7 feet above the foundation.

2.9 ITS CCTV CAMERA

- A. Manufacturers: Subject to compliance with requirements, available manufacturers offering products that may be incorporated into the Work include, but are not limited to, the following:
 - 1. Axis
- B. The Contractor shall furnish and install a Pole Mounted The zoom ratio shall be 35x Optical, 12x Digital, minimum.
- C. The camera shall be an IP type CCTV camera.
- D. The camera shall have an auto focus with manual override capability.
- E. The camera shall have lens aperture ratio of: f/1.4 to f/3.7 (wide to telephoto).
- F. The camera shall support variable zoom lens speeds.
- G. The CCTV camera shall display on-screen azimuth and elevation position indications in degrees and optical and digital zoom levels.
- H. The Contractor shall program the CCTV camera with up to four zones, including at a minimum: North, South, East, and West directional zones.
- I. The CCTV camera shall be programmable to blank out up to eight (8), four-sided areas to electronically block portions of the camera's field of view from being displayed. These privacy zones shall move and adjust sizing synchronously with camera movements and degree of lens zooming.

- J. The CCTV camera shall display a minimum of 20 programmable characters for on-screen camera ID, preset position, sector, and alarm titles.
- K. The position of the on-screen text shall be adjustable to appear at selectable positions on the CCTV camera screen image.
- L. The camera shall provide a variable speed tilt speed range of up to 180° per second.
- M. The camera shall provide a variable speed pan speed range of up to 180° per second.
- N. The camera Pan/Tilt mechanism shall provide a proportional speed Pan and Tilt ability, where the speed decreases automatically as the zoom level increases.
- O. The camera shall provide a 360° continuous pan rotation without mechanical interference.
- P. The camera shall provide a 180° tilt range.
- Q. The CCTV camera assembly shall include an auto-flip function to automatically reposition the camera 180-degrees for uninterrupted viewing, in the correct orientation, as the camera moves to view objects beneath the dome.
- R. The camera shall include a minimum of 80 presets. The movement to the preset shall occur within one second (maximum) and with a 0.1 degree of positioning accuracy.
- S. The CCTV camera shall include titles for each preset with a minimum of 20 characters per preset title.
- T. The camera shall provide a minimum of 704H x 576V effective pixels.
- U. The camera shall include an image sensor of 1/3 or 1/4 inch, nominal.
- V. The camera shall include a zoom lens of 3.4 mm to 119 mm, minimum focal length.
- W. The camera shall have Color and Black & White video image display modes incorporating both automatic and manual override image mode selection. The camera shall transition automatically to a Black & White mode (when in automatic mode) when the luminance level reaches a user predefined threshold. At all times the camera shall provide a full motion video output at 30 frames per second.
- X. The CCTV camera shall incorporate electronic image stabilization to reduce the effects of vibration and wind gusts on the displayed video image.
- Y. The camera shall include both automatic iris control and an override for manual iris adjustments.
- Z. The CCTV camera's wide dynamic range shall be $\geq 128X$.
- AA. The camera's sensitivity shall be sufficient to provide a clear, usable color video image display with a scene illumination of ≤ 0.7 lux at an aperture of F1.6, nominal.

- BB. The camera dome housing shall be provided by the camera manufacturer as an integrated product. See Dome Requirements, below.
- CC. The power input requirements for the CCTV camera and dome shall be 24 VAC, or PoE+; selectable.
- DD. No alarm contacts shall be wired.
- EE. Unless otherwise specified, the equipment inside the CCTV camera shall remain functional with outside temperatures ranging from -40° C to 50° C (-40° F to 122° F).
- FF. The camera and dome assembly shall sustain normal operations when subject to transient voltages, power surges, and sags.
- GG. The camera manufacturer shall have a minimum of 12 installed units of dome type CCTV cameras at outdoor installations for ITS applications, operational for at least six (6) months.
- HH. The Contractor shall have a named Systems Integrator with CCTV and IP networking experience (including experience with CCTV hardware, systems interconnection and IP network configuration). The Contractor and/or systems integrator shall have installed at least two (2) similar CCTV systems with 12 or more cameras, operational for at least six (6) months.
- II. The dome shall be a maximum of 12" diameter. Unless otherwise specified, the equipment inside the dome shall remain functional with outside temperatures ranging -40°C to 50°C (-40°F to 122°F). Unless otherwise specified, the equipment inside the dome shall remain functional with an outside relative humidity from 10-100%. The dome enclosure shall include a heater, as required to maintain the specified operational temperature range. The camera and dome shall withstand 90 MPH winds. The maximum total weight for the combined CCTV camera and dome assembly shall be 15 lbs or less. The dome assembly shall be sealed and shall be rated IP66, or better, for ingress protection against air contaminants and water.
- JJ. The CCTV assembly shall be suitable for the environment within which it is to be installed.
- KK. The lower dome cover shall be distortion free, optically corrected, acrylic plastic with no fastening holes or other visual impairments.
- LL. The camera and dome assembly shall include a single composite cable containing a CAT 6 network cable for connection to the IP CCTV Camera, 22 AWG stranded and shielded conductors for data communication spares, 16 AWG stranded conductors for camera power, heater power and ground. Cabling shall terminate into a single MS-style connector that plugs into the top of the dome. The dome shall accommodate mounting atop a steel pole. The mounting shall permit the camera to view 2° above horizontal. The mounting shall also support a pole-to-camera rotating tenon that allows the camera to be horizontally rotated as desired. The Contractor shall seal the top of the camera dome to assure weather tightness.
- MM. The pendent mount connector type shall be a 1.5" NTP male thread.

- NN. There shall be surge protection within the dome enclosure for the signal and power. This surge protection is in addition to the surge protection specified for use in the CCTV Equipment Cabinet.
- OO. Power Input to the IP CCTV Camera shall be Power over Ethernet (PoE) or 24 VAC nominal; and shall include powering the camera heater.
- PP. The dome manufacturer shall have a minimum of 12 installed units of dome type CCTV cameras at outdoor locations used for ITS applications and operational for at least six (6) months.
- QQ. The camera and dome assembly manufacturer shall provide a twelve month minimum warranty, from the date of installation.

PART 3 - EXECUTION

3.1 INSTALLATION

- A. Comply with NECA 1.
- B. Comply with BICSI TDMM for layout and installation of communications equipment rooms.
- C. Bundle, lace, and train conductors and cables to terminal points without exceeding manufacturer's limitations on bending radii. Install lacing bars and distribution spools.
- D. Coordinate layout and installation of communications equipment with Owner's telecommunications and LAN equipment and service suppliers. Coordinate service entrance arrangement with local exchange carrier.
 - 1. Meet jointly with Owner's Security and Information Technology Department representatives, and Owner to exchange information and agree on details of equipment arrangements and installation interfaces.
 - 2. Record agreements reached in meetings and distribute them to other participants.
 - 3. Adjust arrangements and locations of distribution frames, cross-connects, and patch panels in equipment rooms to accommodate and optimize arrangement and space requirements as shown on plans.
 - 4. Adjust arrangements and locations of equipment with distribution frames, cross-connects, and patch panels of cabling systems of other communications, electronic safety and security, and related systems that share space in the MTA Communications Room (Room 001A).
- E. Coordinate location of power raceways and receptacles with locations of communications equipment requiring electrical power to operate.
- F. Install Telecommunications Equipment Infrastructure according to manufacturer's specifications and guidelines. Coordinate with other trades for complete installation, fittings and additional accoutrements.

3.2 SLEEVE AND SLEEVE SEAL INSTALLATION FOR ELECTRICAL PENETRATIONS

- A. Install sleeves and sleeve seals at penetrations of exterior floor and wall assemblies. Comply with all State, Federal and AHJ requirements.

3.3 FIRESTOPPING

- A. Comply with all State, Federal and AHJ requirements.
- B. Comply with TIA-569-B, Annex A, "Firestopping."
- C. Comply with BICSI TDMM, "Firestopping Systems" Article.

3.4 GROUNDING

- A. Install grounding according to BICSI TDMM, "Grounding, Bonding, and Electrical Protection" Chapter.
- B. Comply with J-STD-607-A.
- C. Connect grounding with a minimum No. 6 AWG grounding electrode conductor to suitable electrical building ground.
- D. Bond metallic equipment to ground, using not smaller than No. 6 AWG equipment grounding conductor.

3.5 IDENTIFICATION

- A. Identify system components, wiring, and cabling complying with TIA-606-A.
- B. Labels shall be preprinted or computer-printed type.
- C. Label all Equipment Racks by number with phenolic engraved plates – yellow background with black text.

END OF SECTION